

E1701M Motion Controller

Users Manual

© 2014-2022 by HALaser Systems

Table Of Contents

1 Copyright.....	3
2 History.....	5
3 Safety.....	6
4 Overview.....	7
4.1 Features.....	7
5 Position Within The System.....	8
6 Board And Connectors.....	9
6.1 Ethernet.....	9
6.1.1 Ethernet Configuration With Windows.....	10
6.1.2 Ethernet Configuration With Linux.....	10
6.2 USB.....	11
6.3 Power.....	11
6.4 Power LED.....	12
6.5 User LEDs.....	12
6.6 Reset-Button.....	12
6.7 Micro-SD-Card.....	13
6.7.1 Firmware Update.....	15
6.8 Digi I/O.....	16
6.9 Opto-Configuration.....	18
6.10 Input State LEDs.....	18
6.11 Stand-Alone Operation.....	18
6.11.1 Stand-alone mode JOG1.....	18
7 E1701base.....	20
8 Programming Interfaces.....	21
8.1 E1701M Binary API Functions.....	21
8.1.1 E1701M Binary API Error Codes.....	32
8.2 E1701M ASCII Commands.....	32
APPENDIX A – IDC connector pin numbering.....	40
APPENDIX B – Board dimensions.....	41

1 Copyright

This document is © by HALaser Systems.

E1701M motion controller board, its hardware and design are copyright / trademark / legal trademark of HALaser Systems.

All other names / trademarks are copyright / trademark / legal trademark of their respective owners.

Portions of the E1701M firmware are based on lwIP 1.4.0 (or newer):

Copyright (c) 2001, 2002 Swedish Institute of Computer Science.

All rights reserved.

Redistribution and use in source and binary forms, with or without modification, are permitted provided that the following conditions are met:

1. Redistributions of source code must retain the above copyright notice, this list of conditions and the following disclaimer.
2. Redistributions in binary form must reproduce the above copyright notice, this list of conditions and the following disclaimer in the documentation and/or other materials provided with the distribution.
3. The name of the author may not be used to endorse or promote products derived from this software without specific prior written permission.

THIS SOFTWARE IS PROVIDED BY THE AUTHOR "AS IS" AND ANY EXPRESS OR IMPLIED WARRANTIES, INCLUDING, BUT NOT LIMITED TO, THE IMPLIED WARRANTIES OF MERCHANTABILITY AND FITNESS FOR A PARTICULAR PURPOSE ARE DISCLAIMED. IN NO EVENT SHALL THE AUTHOR BE LIABLE FOR ANY DIRECT, INDIRECT, INCIDENTAL, SPECIAL, EXEMPLARY, OR CONSEQUENTIAL DAMAGES (INCLUDING, BUT NOT LIMITED TO, PROCUREMENT OF SUBSTITUTE GOODS OR SERVICES; LOSS OF USE, DATA, OR PROFITS; OR BUSINESS INTERRUPTION) HOWEVER CAUSED AND ON ANY THEORY OF LIABILITY, WHETHER IN CONTRACT, STRICT LIABILITY, OR TORT (INCLUDING NEGLIGENCE OR OTHERWISE) ARISING IN ANY WAY OUT OF THE USE OF THIS SOFTWARE, EVEN IF ADVISED OF THE POSSIBILITY OF SUCH DAMAGE.

Portions of the E1701M firmware are based on FatFS R0.10a (or newer):

FatFs module is an open source software to implement FAT file system to small embedded systems. This is a free software and is opened for education, research and commercial developments under license policy of following terms.

Copyright (C) 2014, ChaN, all right reserved.

- The FatFs module is a free software and there is NO WARRANTY.
- No restriction on use. You can use, modify and redistribute it for personal, non-profit or commercial product UNDER YOUR RESPONSIBILITY.
- Redistributions of source code must retain the above copyright notice.

Portions of the E1701M firmware are based on StarterWare 2.0 (or newer):

Copyright (C) 2010 Texas Instruments Incorporated - <http://www.ti.com/>

Redistribution and use in source and binary forms, with or without modification, are permitted provided that the following conditions are met:

- Redistributions of source code must retain the above copyright notice, this list of conditions and the

following disclaimer.

- Redistributions in binary form must reproduce the above copyright notice, this list of conditions and the following disclaimer in the documentation and/or other materials provided with the distribution.
- Neither the name of Texas Instruments Incorporated nor the names of its contributors may be used to endorse or promote products derived from this software without specific prior written permission.

THIS SOFTWARE IS PROVIDED BY THE COPYRIGHT HOLDERS AND CONTRIBUTORS "AS IS" AND ANY EXPRESS OR IMPLIED WARRANTIES, INCLUDING, BUT NOT LIMITED TO, THE IMPLIED WARRANTIES OF MERCHANTABILITY AND FITNESS FOR A PARTICULAR PURPOSE ARE DISCLAIMED. IN NO EVENT SHALL THE COPYRIGHT OWNER OR CONTRIBUTORS BE LIABLE FOR ANY DIRECT, INDIRECT, INCIDENTAL, SPECIAL, EXEMPLARY, OR CONSEQUENTIAL DAMAGES (INCLUDING, BUT NOT LIMITED TO, PROCUREMENT OF SUBSTITUTE GOODS OR SERVICES; LOSS OF USE, DATA, OR PROFITS; OR BUSINESS INTERRUPTION) HOWEVER CAUSED AND ON ANY THEORY OF LIABILITY, WHETHER IN CONTRACT, STRICT LIABILITY, OR TORT (INCLUDING NEGLIGENCE OR OTHERWISE) ARISING IN ANY WAY OUT OF THE USE OF THIS SOFTWARE, EVEN IF ADVISED OF THE POSSIBILITY OF SUCH DAMAGE.

Copyright (c) 2008-2010 Texas Instruments Incorporated. All rights reserved.

Software License Agreement

Texas Instruments (TI) is supplying this software for use solely and exclusively on TI's microcontroller products. The software is owned by TI and/or its suppliers, and is protected under applicable copyright laws. You may not combine this software with "viral" open-source software in order to form a larger program.

THIS SOFTWARE IS PROVIDED "AS IS" AND WITH ALL FAULTS. NO WARRANTIES, WHETHER EXPRESS, IMPLIED OR STATUTORY, INCLUDING, BUT NOT LIMITED TO, IMPLIED WARRANTIES OF MERCHANTABILITY AND FITNESS FOR A PARTICULAR PURPOSE APPLY TO THIS SOFTWARE. TI SHALL NOT, UNDER ANY CIRCUMSTANCES, BE LIABLE FOR SPECIAL, INCIDENTAL, OR CONSEQUENTIAL DAMAGES, FOR ANY REASON WHATSOEVER.

This is part of AM1808 Sitaraware USB Library and reused from revision 6288 of the Stellaris USB Library.

Portions of the E1701M firmware are based on libzint-backend 2.0 (or newer):

libzint - the open source barcode library, Copyright (C) 2008-2017 Robin Stuart <rstuart114@gmail.com>

Redistribution and use in source and binary forms, with or without modification, are permitted provided that the following conditions are met:

1. Redistributions of source code must retain the above copyright notice, this list of conditions and the following disclaimer.
2. Redistributions in binary form must reproduce the above copyright notice, this list of conditions and the following disclaimer in the documentation and/or other materials provided with the distribution.
3. Neither the name of the project nor the names of its contributors may be used to endorse or promote products derived from this software without specific prior written permission.

THIS SOFTWARE IS PROVIDED BY THE COPYRIGHT HOLDERS AND CONTRIBUTORS "AS IS" AND ANY EXPRESS OR IMPLIED WARRANTIES, INCLUDING, BUT NOT LIMITED TO, THE IMPLIED WARRANTIES OF MERCHANTABILITY AND FITNESS FOR A PARTICULAR PURPOSE ARE DISCLAIMED. IN NO EVENT SHALL THE COPYRIGHT OWNER OR CONTRIBUTORS BE LIABLE FOR ANY DIRECT, INDIRECT, INCIDENTAL, SPECIAL, EXEMPLARY, OR CONSEQUENTIAL DAMAGES (INCLUDING, BUT NOT LIMITED TO, PROCUREMENT OF SUBSTITUTE GOODS OR SERVICES; LOSS OF USE, DATA, OR PROFITS; OR BUSINESS INTERRUPTION) HOWEVER CAUSED AND ON ANY THEORY OF LIABILITY, WHETHER IN CONTRACT, STRICT LIABILITY, OR TORT (INCLUDING NEGLIGENCE OR OTHERWISE) ARISING IN ANY WAY OUT OF THE USE OF THIS SOFTWARE, EVEN IF ADVISED OF THE POSSIBILITY OF SUCH DAMAGE.

3 Safety

The hardware described within this document is designed to control motors. Motions caused by these motors may effect a person's health or may otherwise cause damage. Prior to installation and operation compliance with all relevant safety regulations including additional hardware-controlled safety measures has to be secured. The client shall solely be responsible to strictly comply with all applicable and relevant safety regulations regarding installation and operation of the system at any time.

The hardware described here is shipped without any cover and without prefabricated equipment for electric installation. It is intended to be integrated in machines or other equipment. It is not a device for use "as is", but a component which is intended to be used as part of a larger device, e.g. for integration in a machine with own housing or within an electrical cabinet. Prior to operation compliance with all relevant electric / electromagnetic safety regulations including additional hardware-controlled safety measures has to be secured. The client shall solely be responsible to strictly comply with all applicable and relevant regulations regarding installation and operation of the system at any time.

The hardware described here is an electrostatic sensitive device. This means it can be damaged by common static charges which build up on people, tools and other non-conductors or semiconductors. To avoid such a damage, it has to be handled with care and including all relevant procedures (like proper grounding of people handling the hardware, shielding/covering to not to let a person touch the hardware unwanted, proper packaging in ESD-bags, ...). For more information please refer to related regulations and standards regarding handling of ESD devices. The EMC Directive (2014/30/EU) does not apply to this hardware as it is not intended for an end user (a person without knowledge of EMC) and as it is not otherwise made available on the market.

The Low Voltage Directive (2014/35/EU) does not apply to this hardware as the voltage supply is below the 50V AC / 75V DC limit.

This document describes the E1701M-hardware but may contain errors or may be changed without further notice.

4 Overview

This document describes the E1701M motion controller board, its electrical characteristics and usage.

The E1701M motion controller board is designed for controlling stepper motors through up to four step and direction signals (pulses). Alternatively it can be operated as IO-board with 8 digital inputs and 8 digital outputs which optionally can be operated in opto-insulated mode.

In both cases the communication between the host system and the controller board is done via Ethernet or USB.

4.1 Features

E1701M motion controller offers following features:

- 100 Mbit Ethernet connection
- USB 2.0 connection
- 20 microseconds cycle time and resolution
- command execution time down to 1 microsecond
- maximum stepper motor clock of 500 kHz, speed steps 500 kHz, 250kHz, 125kHz, 62,5 kHz, ..., 5000Hz, 4950 Hz, 4901 Hz, 4854 Hz, ... 1000 Hz, 998 Hz, 996 Hz, 994 Hz, ...
- support of up to four independent axes
- can be operated as IO-board with 8 digital inputs and 8 digital outputs alternatively
- linear, exponential and s-shaped acceleration modes
- freely definable referencing modes with auto-searching for reference switch
- realtime processing
- 512 MByte DDR3 RAM
- 1 GHz CPU clock
- Support for Micro-SD and Micro-SDHC cards
- 8 digital outputs providing either CMOS logical levels or electrically insulated outputs via external power supply for controlling 4 motors via step and direction signals
- 8 freely usable digital inputs expecting either CMOS logical levels or electrically insulated inputs via external power supply for usage as limit-/reference switches or encoder inputs
- two decoders for evaluation of axis position via quadrature encoder signal
- stand-alone operation mode
- very small size of about 87 mm x 55 mm

5 Position Within The System

The E1707M motion controller system can be connected to the host system via Ethernet or USB to receive motion commands from BeamConstruct laser marking application, from ControlRoom process control software or from any other software using E1701M controller:

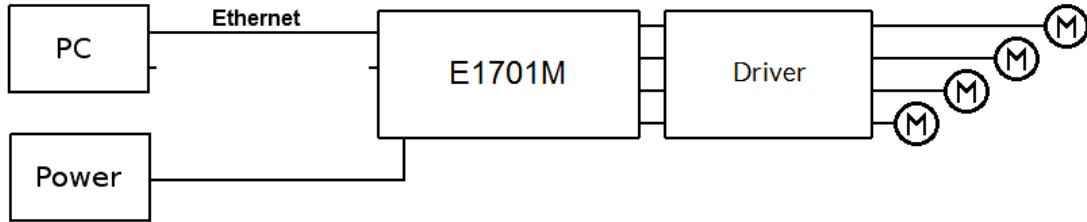

Since 100 Mbit Ethernet provides much faster data transfer than USB 2.0, this connection type is preferred. Especially in case complex motion data with many short movements are used, Ethernet connection is more responsive.

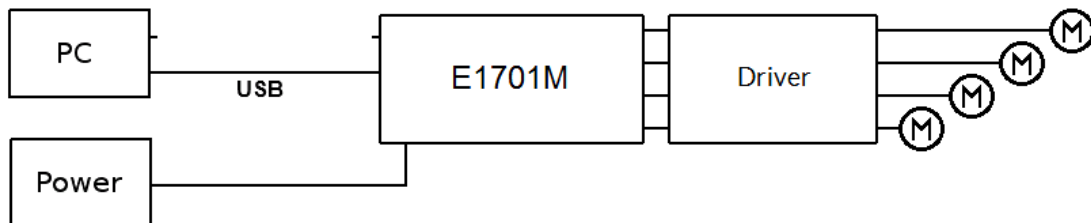

In both cases the board itself has to be connected to a motor driver for each axis to submit step and direction pulses to it.

6 Board And Connectors

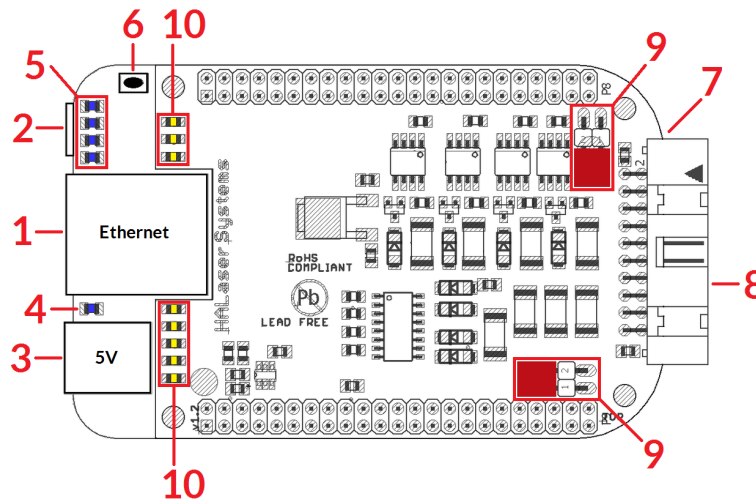

The E1701M motion controller board provides following connectors and interfaces:

1. Ethernet – for communication with the host system, motion commands are submitted via this path
2. USB – optionally for submitting motion commands from host to E1701M card (in case Ethernet is not used)
3. Power – connect with power jack 5V DC
4. Power LED – lights when power is available
5. User LEDs – show operational and error states of card
6. Reset-button – on-board button to restart the board completely
7. Micro-SD-card (on bottom side) – storage place for firmware and extended configuration file, can be used to upgrade firmware, to change the card's IP and other things more
8. Digi I/O - electrically insulated digital in and outputs for transmitting step and direction signals and for checking reference and limit switches
9. Opto-Configuration - choose operation mode for Digi I/Os
10. Input state LEDs – 8 LEDs showing current state of digital inputs

6.1 Ethernet

This is a standard RJ45 Ethernet plug for connection of the board with the host system. The controller board is accessed via this connection, all motion commands and responses are sent via Ethernet. Thus it is recommended for security reasons to have a separate 1:1 connection from the host to the motion controller card by using a separate Ethernet port. In case this is not possible at least an own, physically separated sub-net for all motion controller cards should be set up. This network of course should be separated from normal network completely.

Ethernet connection is initialised during start-up, thus Ethernet cable connecting E1701M board and host system needs to be plugged before the board is powered up.

By default the E1701M controller is using IP 192.168.2.254, thus the Ethernet port the card is connected with needs to belong to subnet 192.168.2.0/24.

 PLEASE NOTE: For security reasons it is highly recommended not to mix a standard communication network with an E1701M network or to connect the motion controller card with a standard network. Here it may be possible someone else in that network (accidentally) connects to that motion controller and causes movements. The IP of the motion controller can be changed. This is necessary e.g. in case an other subnet has to be used or in case the E1701M board has to be operated in multi-card environments where more than one motion controller will be accessed at the same time. The IP can be configured using e1701.cfg configuration file that is placed on Micro-SD-card. To change the IP please perform the following steps:

1. disconnect E1701M board from power and USB
2. remove Micro-SD-card
3. put Micro-SD-card into a desktop computer, this may require a Micro-SD- to SD-card-adapter

4. open the drive that is assigned to the card
5. open file e1701.cfg using a text editor like Notepad or kwrite
6. add a line or edit an existing line "ip1=", here the desired IP has to be appended (as example: when you want to configure IP 192.168.2.13 the line has to be "ip=192.168.2.13" - without any quotation signs
7. save the file
8. unmount and eject the drive the card is assigned to
9. place Micro-SD-card in E1701M board (place without the use of force, notice correct orientation with connectors of SD-card to bottom!)
10. power up controller

When User LEDs do not light up as described below, please check if Micro-SD-card is placed in board correctly.

6.1.1 Ethernet Configuration With Windows

When E1701 scanner controller is accessed via Ethernet, it is recommended to have a 1:1 connection to the host PC for security reasons. Since the controller is working with a static IP (default is 192.168.2.254) the Ethernet port on host PC has to be configured with an IP of same subnet in order to allow access to it. For Windows 10 (and similar) this configuration has to be done using following steps:

1. right-click the network-symbol in your taskbar
2. Select "Open network and internet settings"
3. Select "Ethernet" on the left
4. find the network interface E1803D has to be connected with and select it
5. Click the "Edit" button in section "IP settings"
6. now a window opens where "IPv4" has to be turned on and that has to be configured as follows:

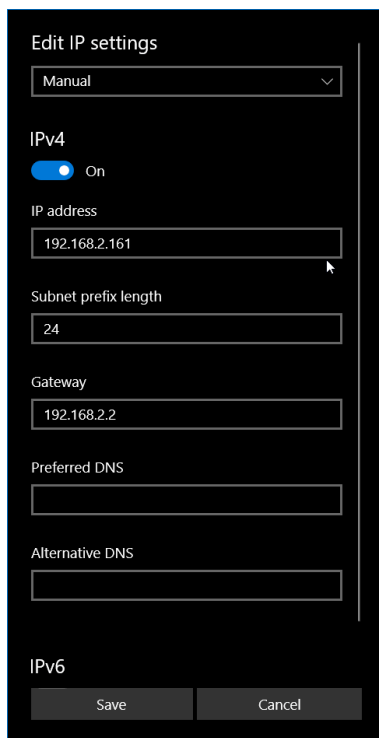

There you can specify an IP for your host PC. It has to belong to network 192.168.2.xxx and can be any number except than 192.168.2.254 (this is already the IP of the scanner card), 192.168.2.0 or 192.168.2.255.

6.1.2 Ethernet Configuration With Linux

When E1701D scanner controller is accessed via Ethernet, it is recommended to have a 1:1 connection to the host PC for security reasons. Since the controller is working with a static IP (default is 192.168.2.254) the

Ethernet port on host PC has to be configured with an IP of same subnet in order to allow access to it. For Linux (with NetworkManager) this configuration has to be done using following steps:

1. right-click the network-symbol in taskbar
2. click "Edit Connections..."
3. select the "Wired" network interface the scanner card is connected with and press button "Edit"
4. go to tab-pane "IPv4 Settings" and configure it as shown below:

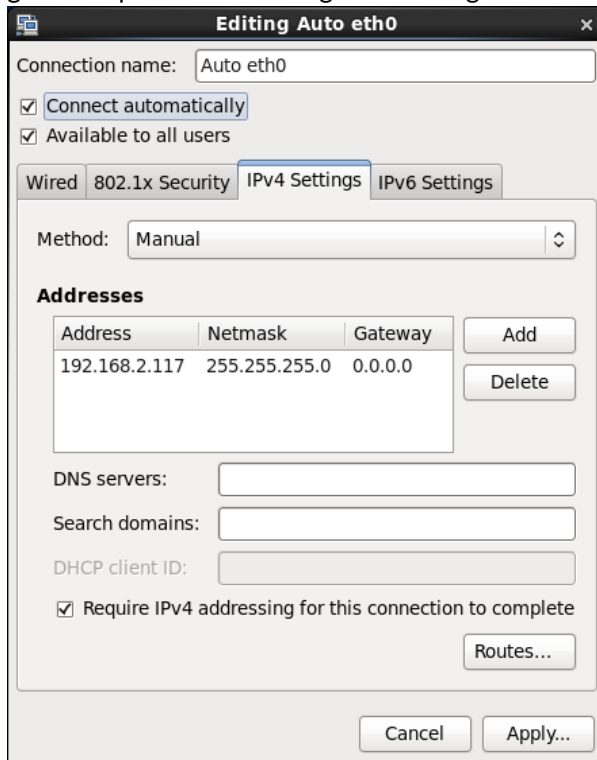

There you can specify an IP for your host PC. It has to belong to network 192.168.2.xxx and can be any number except than 192.168.2.254 (this is already the IP of the scanner card), 192.168.2.0 or 192.168.2.255.

6.2 USB

This is a standard Mini-USB-connector for connection of the board with the host system. It is used to optionally send motion commands to the card. When USB is used for sending all motion commands Ethernet cable does not need to be connected.



PLEASE NOTE: USB 2.0 is much slower than a standard 100 Mbit Ethernet connection, so expect slower execution and longer response times in case of complex motion data!

The required device driver is installed automatically during the installation of the HALsetup software package (Windows) or comes with operating system by default (Linux). E1701M card appears as COM-interface on Windows using any free number for the port. With Linux it appears as /dev/ttyACMx where "x" is any number. These numbers are provided by the operating system automatically.

By default USB provides 5V power supply too. So whenever card has to be stopped, both USB and power have to be disconnected in order to shut it down completely.

It is not recommended to use USB as power supply only, additional, external power should be connected in order to operate E1701M controller correctly.

6.3 Power

Power supply for E1701M motion controller board is done via power jack right beside Ethernet port. Power can be supplied via a 2.1 mm x 5.5 mm centre connector when connected to a positive power supply rated at 5V DC +/- 0.1V and 2.0A (smoothed, positive pole on inner contact). Do not apply voltages in excess of 5V to the DC input. The DC power supply must be grounded.

To avoid high frequency interferences from other electrical equipment or from within the power supply, it is recommended to place a ferrite bead at the cable close to the board. Please also check for correct shielding in respect to the equipment the E1701M card is used within.

It is always recommended to use an external power supply. Nevertheless it may be possible a board can be operated and powered via USB only. This depends highly on the host USB is connected to. So it is up to the user to verify proper operation in this case.

6.4 Power LED

This LED is lit as soon as the board is on some power. This means it may be functional and could emit any signals as soon as this LED is on, but it does not necessarily need to work properly since firmware is not started at this point. Please refer section below for LEDs that show functional state of the board.

6.5 User LEDs

The real operational state of the card is shown by some additional LEDs described here from inner to outer position:

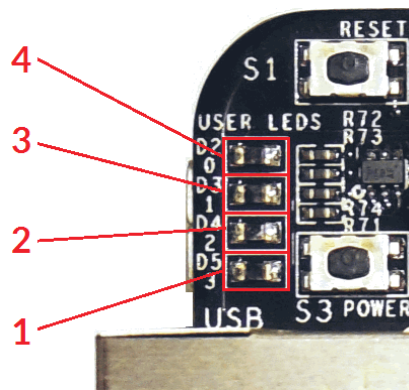

1. Boot- and Alive-LED – this LED is turned on permanently as soon as the card was powered up and the firmware boots properly. When it is not turned on after few seconds, please check if the Micro-SD-card is placed properly and if it contains a working firmware file (for details please refer below). After boot process has completed successfully, it starts blinking slowly. This is an alive-notification, as long as it blinks, the board is working and ready for operation. During motion the blink frequency may go down. Only in case it does not blink any more for more than 15 seconds, the board has died for some reason and should be restarted.
2. Motion Active LED – this LED is turned on as long as some motion operation is running. This includes operations that wait for a queued motion command, like a delay or like waiting for an external signal.
3. unused – the third LED is currently unused.
4. Error-LED – this LED is turned on as soon as a fatal error occurs that normally should never happen. When it is on, in most cases board can't continue with operation until the reason for error is removed and the board is restarted. In case this LED is turned on please:
 - check if no other boards are plugged onto the controller
 - check if you are using latest firmware and host software
 - check all connections and cables
 - undo your latest changes in hardware and configurationIf these steps do not help, please contact us for further assistance.

6.6 Reset-Button

When this button is pressed for at least 20 milliseconds, it restarts the card completely. A current motion operation is stopped without any deceleration, all signals are disabled and all remaining motion commands are dropped. After releasing this button, the firmware will start again.

6.7 Micro-SD-Card

The Micro-SD card is storage place for firmware and configuration files. Here SD and SDHC cards with storage space of up to 32 GB are supported.

To remove the Micro-SD-card, first disconnect all power from the E1701M board completely (including USB, Power LED has to go off). Next press Micro-SD card gently into the board until you can hear a klick-noise. Then you can pull it out of the board. To place a Micro-SD card the same has to be done in reverse order: place it into the E1701M boards card slot and press it gently until a noise signals locking of the card. Now the board can be powered.

E1701M baseboard is shipped with a card containing firmware and configuration files:

- E1701.fwi – firmware file that is used to operate the board, to be replaced when a firmware update is provided
- E1701.cfg – configuration text file, can be edited using a text editor in order to modify cards configuration

To use an other Micro-SD card than the one shipped with the board, following conditions have to be met:

- maximum total size of 32 GB (SD or SDHC card)
- FAT32 formatted
- using only one partition
- BOOT-flag is set
- E1701.fwi file available on card (E1701.cfg file is optional)

The E1701.cfg configuration file can contain several parameters and its values. Both are separated by an equal-sign. Every of the possible parameter/value pairs has to be located in an own line. Following configuration parameters are possible:

Parameter	Description	Example
ip1	Configures IP of Ethernet port. Here only IPs in xxx.xxx.xxx.xxx notation are allowed but no host or domain names.	ip1=192.168.2.100 specifies IP 192.168.2.100 to be used for Ethernet interface on next startup
passwd	Specifies an access password that is checked when card is controlled via Ethernet connection. This password corresponds to password specified with function <code>E1701M_set_password()</code> , please refer below for a detailed description. When a client computer connects to the card without sending the correct password, Ethernet connection to this host is closed immediately. PLEASE NOTE: this password does not replace any network security mechanisms and does not give the possibility to operate E1701M controller via insecure networks or Internet! It is transferred unencrypted and therefore can be "hacked" easily. Intention of this password is to avoid collisions between several E1701M cards that operate in same network and are accessed by several software instances. Maximum allowed length of the password is 48 characters. It is recommended to not to use any language-specific characters.	passwd=myCardPwd set a password "myCardPwd"





initfile	<p>Specifies an initialisation file which is executed on start-up of the controller and which can be used to define some own default settings or to perform some special movements. This init-file is a plain ASCII-file which consists of control commands as described in section “8.2 E1701M ASCII Commands” below. Here every command has to be placed in a separate line. It will be executed in the order it appears in the file. The result of every command is written into the internal logfile and can be fetched with the control command “cglog” (please refer below for details).</p> <p>PLEASE NOTE: this initialisation file is executed immediately and without additional user interaction, so it has to be ensured possibly contained movement operations can not be dangerous and/or cause any damage!</p> <p>This function requires firmware version 29 or higher.</p>	<p>initfile=0:/init.txt specifies the file “init.txt” on microSD-card to be executed on controller start-up</p>
dirdelay	<p>Adds a delay between the edge of the direction signal and the first pulse. This may be necessary in cases where the motor controller does not react fast enough and needs a defined delay between both signals. The delay is given in unit “ticks” where every “tick” is equal to 2 usec.</p> <p>This parameter requires firmware version 31 or higher. With firmware version 32 or higher the delay specified here does not only apply between direction signal turned on and first pulse but also between last pulse and before the direction signal is turned off.</p>	<p>dirdelay=500 specifies a delay of 1 msec to be issued between direction signal and first pulse (500 ticks = 1000 usec = 1 msec)</p>
standalone	<p>Enables a stand-alone operating mode where no controlling host-PC is mandatory but where axis movements can be initiated by setting some related input pins. For further details please refer to section “6.11 Stand-Alone Operation” below.</p> <p>This function requires firmware version 29 or higher.</p>	<p>standalone=jog1 Enable JOG1 stand-alone mode</p>
jogspd0 .. jogspd15	<p>Define 15 speed values for stand-alone mode JOG 1 as described in section “6.11 Stand-Alone Operation” below.</p> <p>This function requires firmware version 29 or higher.</p>	<p>jogspd11=800 set the jog-speed that corresponds to input pattern 11 to 800 increments/sec</p>
usb	<p>When this parameter is set to 0, USB interface is disabled completely. This means it is no longer possible to connect to E1701M USB serial interface via terminal software or via BeamConstruct and it is also no longer possible to retrieve BeamConstruct PRO license via USB. This option can be used to suppress illegal access to USB and saves some power.</p>	<p>usb=0 turn off USB interface</p>

eth	<p>This parameter specifies the behaviour of the Ethernet interface. Here following values can be set:</p> <ul style="list-style-type: none"> • 0 – Ethernet network interface is disabled completely. This means it is no longer possible to connect to E1701M via Telnet or via BeamConstruct. All SNTP-functionalities are disabled too. This option can be used to suppress illegal access to Ethernet, to save several seconds of startup-time and to save some power. • 1 – this is the default mode which enables the Ethernet interface and checks once at the beginning if some Ethernet hardware is connected to the controller card; when the “eth”-parameter is not specified at all, the resulting behaviour is the same • 2 – this enables Ethernet polling mode; instead of checking for an Ethernet device only once during boot, in this mode the interface is polled regularly until an electrical connection is detected. As long as the controller is polling, the Alive-LED blinks very slow and toggles once in about 20 seconds, when an Ethernet device was detected, the blink frequency changes to normal speed; PLEASE NOTE: when this mode is used, access via USB is limited, so “eth” should be set to “2” only when no communication via USB is intended. The “eth”-value of 2 requires a firmware version 39 or newer 	eth=0 – turn off Ethernet interface completely
pethd	<p>When Ethernet connection is used, it has to be established on power-up of the controller card as this connection is set-up and configured by the controller only once during boot. There may be situations where the other side of the Ethernet connection can not boot up as fast as E1701. In such cases this parameter can be used. It delays initialisation of Ethernet by the time given as parameter. The time is specified in unit “delayticks” where one “delaytick” is equal to about 0,5 seconds. As long as the controller is halted during initialisation due to this parameter, this is signalled by the Stop-LED (please refer to 6.5 User LEDs for details). This feature requires a firmware version 34 or newer.</p>	pethd=20 – halt initialisation of the controller for about 10 seconds prior to initialisation of Ethernet interface
digidebc	<p>Sets a debouncing time / filter time for the digital inputs in order to not to let the inputs react on noise or bouncing of mechanical inputs. The debouncing value is given in time-units where every time-unit is equal to 31 usec. By default 7 time-units are set.</p>	digidebc=10 set the debounce-time to 310 usec

6.7.1 Firmware Update

As described above the firmware is located on Micro-SD-Card and therefore can be updated easily:

1. remove the Micro-SD-Card as described above
2. download a new firmware from <https://halaser.systems/download/Firmware/E1701> (the higher the number in the file name, the newer the firmware is)
3. copy the contents of this ZIP-file to Micro-SD-Card (please take care about e1701.cfg in case it contains a changed configuration)
4. reinsert Micro-SD-Card as described in previous section

6.8 Digi I/O

The 20 pin connector provides 8 lines for input and 8 lines for output of digital signals that can work on CMOS voltage level (non-insulated mode) or via opto-couplers (electrically insulated mode with external power supply) optionally. The output lines are directly assigned to axis signals while the input lines can be used freely. The operation mode depends on jumper settings described below. The connector is used as follows:

Upper Row Of Pins	Signal	Voltage	Remarks	Lower Row Of Pins	Signal	Voltage	Remarks
1	V _{ext}	5..24V	External voltage input to be used in opto-insulated mode only	2	GND _{ext}	GND	External ground
3	Step0	0/5V or 0/V _{ext}	Step signal for axis 0	4	DIn0	0/5V or 0/V _{ext}	Used for encoder pulses when decoder 0 is configured
5	Step1	0/5V or 0/V _{ext}	Step signal for axis 1	6	DIn1	0/5V or 0/V _{ext}	
7	Step2	0/5V or 0/V _{ext}	Step signal for axis 2	8	DIn2	0/5V or 0/V _{ext}	Used for encoder pulses when decoder 1 is configured
9	Step3/ Enable3	0/5V or 0/V _{ext}	Step signal for axis 3 or optional enable-signal	10	DIn3	0/5V or 0/V _{ext}	
11	Dir0	0/5V or 0/V _{ext}	Direction signal for axis 0	12	DIn4	0/5V or 0/V _{ext}	
13	Dir1	0/5V or 0/V _{ext}	Direction signal for axis 1	14	DIn5	0/5V or 0/V _{ext}	
15	Dir2	0/5V or 0/V _{ext}	Direction signal for axis 2	16	DIn6	0/5V or 0/V _{ext}	
17	Dir3/ Enable7	0/5V or 0/V _{ext}	Direction signal for axis 3 or optional enable-signal	18	DIn7	0/5V or 0/V _{ext}	
19	V	5V	Board voltage output, to be used only when not operating in insulated mode	20	GND	GND	Board-internal ground

V_{ext} and GND_{ext} depend on opto-configuration as described below. In opto-insulated mode (opto-configuration jumpers not set) external power supply has to be connected to these inputs. Then Step0..Step3, Dir0..Dir3, optional Enable3, Enable7 and DIn0..DIn7 work in respect to this external power.

 **WARNING:** When no opto-insulated mode is selected (opto-configuration jumpers are set), do NOT FEED ANY POWER into V_{ext}, this would cause damage to the E1701M board! In this case V_{ext} is equal to V (5V) of the board and GND_{ext} is connected to boards ground GND.

Maximum current for every output is 15 mA when internally powered (non-insulated mode), here it is recommended to use an external power supply. Maximum current for outputs Step0..Step3 is 50 mA when externally powered (V_{ext} in insulated mode).

Signal output lines Step0..Step3 and Dir0..Dir3 work in open collector mode and have to be wired as shown in picture below:

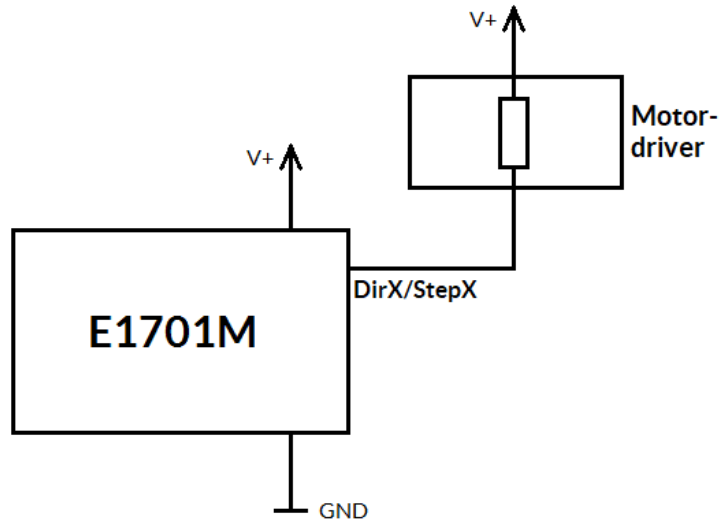

Here “DirX/StepX” symbolises one of the step- or direction outputs, V+ is either V (5V internal, non-insulated mode with both jumpers set) or V_{ext} (up to 24V external, insulated mode with both jumpers removed). GND is either GND (non-insulated mode) or GND_{ext} (insulated mode). The internal resistor of the connected device is not allowed to have less than 490 Ohms in order to not exceed the given current limits.

Step-signals emitted at Step0, Step1, Step2 and Step3 work with a base-frequency of 500 kHz. This is also the maximum output frequency to drive a stepper motor with. Lower speeds are calculated by doing a whole-numbered division of this base-frequency which results in possible speed steps 500 kHz, 250kHz, 125kHz, 62,5 kHz, ..., 5000Hz, 4950 Hz, 4901 Hz, 4854 Hz, ... 1000 Hz, 998 Hz, 996 Hz, 994 Hz, ...

So as smaller the output frequency is, the more speed steps are available and the closer the actual output frequency is to the given nominal frequency. Or in other words, the higher the output speed is, the lower is the motion accuracy:

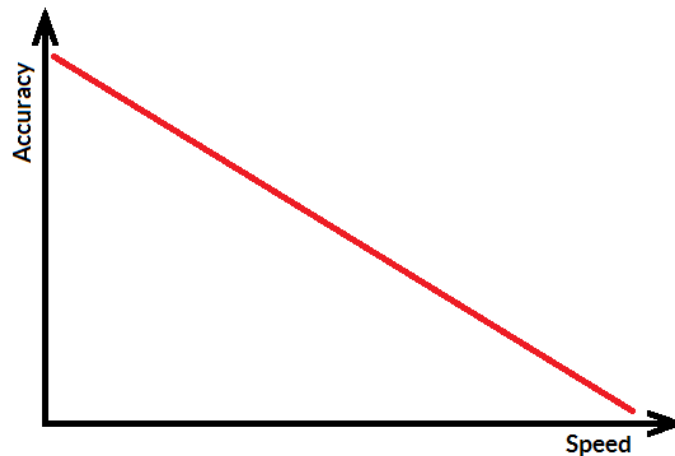

When E1701M is operated as IO-board, the different output are mapped to related binary values:

Bit	Value	Output
0	1	Step0
1	2	Step1
2	4	Step2
3	8	Step3
4	16	Dir0
5	32	Dir1
6	64	Dir2
7	128	Dir3

When DIn0/DIn1 or DIn2/DIn3 are used as encoder inputs, a 90 degree phase shifted signal is expected. For digital input mode (standard mode which is permanently active for DIn4..DIn7 and for DIn0/DIn1 and DIn2/DIn3 when no encoder mode is enabled) input signals are debounced and need to stay on HIGH or LOW level for at least 0,3 msec in order to be an valid signal.

6.9 Opto-Configuration

Using these jumpers the operation mode for Step0..Step3, Dir0..Dir3 and DIn0..DIn7 can be chosen. When they are set, the opto-couplers are powered internally. In this mode it is not working in opto-insulated mode and all I/Os are using TTL level signals.

When they are not set, external power and ground has to be provided at 20 pin connector (as described above) and these digital I/Os are working in electrically insulated, opto-coupled mode.

Here always both jumpers have to be set or removed together. Setting only one of them is not allowed and may cause damage to the E1701M motion controller.

6.10 Input State LEDs

Current state of digital inputs is signalised via 8 green LEDs. Every LED is assigned to exactly one digital input signal. As long as the LED is turned on, there is a HIGH signal detected at the related input. These LEDs can be used to check unexpected conditions manually, e.g. in case motors do not move any more because they have hit a limit switch or to check referencing mode.

6.11 Stand-Alone Operation

E1701M motor controller cards can be operated in stand-alone mode. In this mode motion is triggered by external (manually controlled) input signals which start a motion of the related axis as long as the input signal is HIGH and stop the motion (with defined stop deceleration) as soon as it goes to LOW. Using this functionality e.g. some kind of manual control can be implemented where hardware-buttons are used to move the axes.

In this mode the board can operate without direct control of a host-PC but optionally can combine both methods by sending control data in parallel (as described in section "8 Programming Interfaces").

6.11.1 Stand-alone mode JOG1

Using configuration parameter `standalone` in `e1701.cfg` (as described above in section "6.7 Micro-SD-Card") the stand-alone mode JOG1 can be enabled. In this mode two input pins can be used to start motion of two axes each in positive or negative direction and two other input pins can be used to select a motion speed out of 16 different values to be used for these axes movement.

This function requires firmware version 29 or higher.

In JOG1-stand-alone mode the 20 pin connector has a fixed pin-out:



Upper Row Of Pins	Signal	Voltage	Remarks	Lower Row Of Pins	Signal	Voltage	Remarks
1	V _{ext}	5..24V	Input voltage to be used in opto-insulated mode only	2	GND _{ext}	GND	External ground
3	Step0	0/5V or 0/V _{ext}	Step signal for axis 0	4	Axis0+	0/5V or 0/V _{ext}	Move axis 0 in positive direction
5	Step1	0/5V or 0/V _{ext}	Step signal for axis 1	6	Axis0-	0/5V or 0/V _{ext}	Move axis 0 in negative direction
7	Speed0	0/5V or 0/V _{ext}	Speed signal bit 0	8	Axis1+	0/5V or 0/V _{ext}	Move axis 1 in positive direction
9	Speed1	0/5V or 0/V _{ext}	Speed signal bit 1	10	Axis1-	0/5V or 0/V _{ext}	Move axis 1 in negative direction
11	Dir0	0/5V or 0/V _{ext}	Direction signal for axis 0	12	Spd+	0/5V or 0/V _{ext}	One step up to higher motion speed
13	Dir1	0/5V or 0/V _{ext}	Direction signal for axis 1	14	Spd-	0/5V or 0/V _{ext}	One step down to lower motion speed
15	Speed2	0/5V or 0/V _{ext}	Speed signal bit 2	16	DIn6	0/5V or 0/V _{ext}	
17	Speed3	0/5V or 0/V _{ext}	Speed signal bit 3	18	DIn7	0/5V or 0/V _{ext}	
19	V	5V	Board voltage, to be used only when not operating in insulated mode	20	GND	GND	Board-internal ground

- Step0/Step1 outputs provide the step pulses for axes 0 and 1
- Dir0/Dir1 outputs provide the direction signals for axes 0 and 1
- Speed0..Speed3 outputs provide a bitpattern which corresponds to the current speed selected for moving the two axes 0 and 1. Here a binary value in range 0..15 is given which can be changed by the input pins Spd+ and Spd- and which corresponds to the configuration parameters jogspd0..jogspd15 which itself set the real speed to be used at the selected speed step
- Axis0+ input initiates a movement of axis 0 in positive direction using the default acceleration on start and speed specified by Spd+/Spd- and the current jogspd-value; the axis is moved as long as the input is HIGH, when it goes to low, it is stopped with default stop deceleration
- Axis0- input initiates a movement of axis 0 in negative direction using the default acceleration on start and speed specified by Spd+/Spd- and the current jogspd-value; the axis is moved as long as the input is HIGH, when it goes to low, it is stopped with default stop deceleration
- Axis1+ input initiates a movement of axis 1 in positive direction using the default acceleration on start and speed specified by Spd+/Spd- and the current jogspd-value; the axis is moved as long as the input is HIGH, when it goes to low, it is stopped with default stop deceleration
- Axis1- input initiates a movement of axis 1 in negative direction using the default acceleration on start and speed specified by Spd+/Spd- and the current jogspd-value; the axis is moved as long as the input is HIGH, when it goes to low, it is stopped with default stop deceleration
- Spd+ input switches to next higher jog speed step on falling edge until speed value 15 is reached; this speed value is used for axis movements invoked by Axis0+/Axis0-/Axis1+/Axis1- inputs; the corresponding speed value 8inm unit increments/sec) is defined by configuration parameters jogspd0..jogspd15, the currently used speed step value is signalled by Speed0..Speed3 outputs
- Spd- input switches to next lower jog speed step on falling edge until speed value 0 is reached; this speed value is used for axis movements invoked by Axis0+/Axis0-/Axis1+/Axis1- inputs and is defined by configuration parameters jogspd0..jogspd15, the current speed step value is signalled by Speed0..Speed3 outputs
- DIn6/DIn7 inputs are free for any use and can be used e.g. as reference switch inputs for axes 0 and 1

7 E1701base

The E1701base extension is a mounting help for easy installation on DIN rails and other possibilities of mechanical integration into machines:

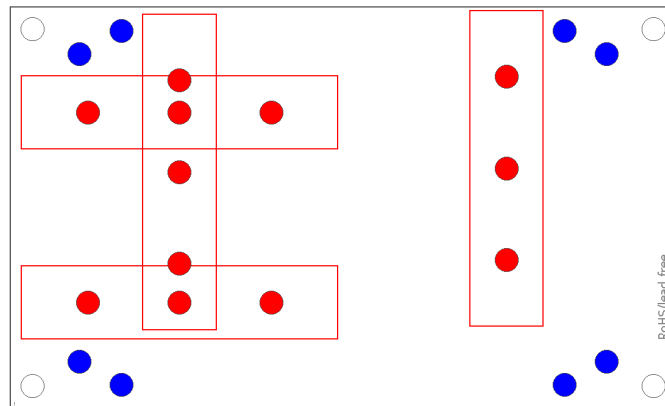

RED - mounting positions for DIN rail locks/DIN rail adapters (bottom side). Pairs of locks can be mounted in one of 2 possible orientations. Here locks of type Phoenix Contact 1201578 or similar can be used. With these locks the board then can be clamped on a DIN rail.

BLUE - mounting holes for the E1701M motor controller card on top of the E1701base in one of two possible positions. These holes are symmetrically arranged so that the board can be mounted by 180 degrees rotated. Here Hex stands/distance bolts can be screwed in where the controller card is mounted on top.

Mounting procedure for E1701base:

1. Identify suitable positions (**RED**) for two DIN rail locks and mount them on bottom side (two or three screws from top side into the lock on bottom)
2. Mount hex-stands or distance bolts in at least four of the given mounting holes (**BLUE**).
3. Mount E1701M on top of these hex-stands/distance bolts
4. Clamp the board on your DIN rail

Without the DIN rail clamps the board also can be used as top-cover for the E1701M.

8 Programming Interfaces

There are two possibilities to access the E1701M motion controller out of own applications: via binary API that makes use of native shared libraries (DLL for Windows, .so shared object for Linux) or via an ASCII command interface that is accessible through USB serial interface of the card.

8.1 E1701M Binary API Functions

The e1701m.dll / libe1701m.so shared library provides an own programming interface that gives the possibility to access and control up to four axes connected to E1701M motion controller card.

The libraries are contained in the main software package, so to get them please go to <https://halaser.de/download.php> and install the package which belongs to your operating system.

Link libraries (.lib-files, Windows only), required header files and usage examples can be found in our public GIT-repository at <https://sourceforge.net/p/oapc/code/ci/master/tree/libe1701m/>.

The E1701M controller mainly operates functions in handshake mode, means after sending a command, completion of it has to be waited for. This is true for motion commands. Beside of that some commands that configure parameters like speed or acceleration can be called immediately and without waiting for a response from card. Additionally there are some functions that can be enqueued directly after calling an other function. Here realtime-capabilities of the controller apply, the second command is executed as soon as the previous one is finished. Here no lag and no delays of controlling host system slow down the execution.

E1701M interface uses “increments” as base for all units and parameters and provides following functions:

```
unsigned char E1701M_set_connection(const char *address)
```

This function has to be called as very first. It is used to specify the IP address where the card is accessible at (in case of Ethernet connection) or the serial interface name (in case of USB connection, “COMx” for Windows and “/dev/ttyACMx” for Linux where “x” is the number of its interface). By default IP 192.168.2.254 is used. It returns a card index number that has to be used with all following functions.

Parameters:

address – a char-array containing the IP in xxx.yyy.zzz.aaa notation or the name of the COM port to be used

Return: the board instance number or 0 in case of an error

```
void E1701M_set_password(const char n, const char *ethPwd)
```

Sets a password that is used for Ethernet connection of E1701M card. The same password should be configured on E1701M configuration file e1701.cfg with parameter “*passwd*” to add an additional level of security to an Ethernet controlled card.

 PLEASE NOTE: usage of this password does NOT create enough security to control the card via networks that are accessible by a larger audience, publicly or via Internet! Also when this password is set, the card always should operate in secure, separate networks only!

Every card and every connection should use an own, unique password that can consist of up to 48 characters containing numbers, lower- and uppercase letters and punctuation marks. Due to compatibility reasons no language-specific special character should be used.

When connected via USB, this password is ignored, in this case no authentication is done.

Parameters:

ethPwd – the password to be used to authorise at a E1701M card. To reset a local password for connecting to a card that doesn't has an Ethernet password configured, hand over an empty string "" here

void E1701M_set_logfile(unsigned char n, const char *path)

Using this function a path to a file can be specified where controller log data are written into. These data are uploaded from controller during normal operation cyclically and can be used to find errors in configuration and hardware setup.

Parameters:

n – the 1-based board instance number as returned by `E1701M_set_connection()`

path – full pathname to a file where the log data have to be written into, this file does not have to exist, it will be overwritten on every new connection to controller. Write access is required on specified location for current user. When an empty path is specified, a current log file is closed and writing of log data is disabled.

Return: `E1701M_OK` in case function could be completed successfully or an `E1701M_ERROR_`-code otherwise

int E1701M_open_connection(unsigned char n)

Opens connection to the controller using the parameters specified during call of `E1701M_set_connection()`.

Parameters:

n – the 1-based board instance number as returned by `E1701M_set_connection()`

Return: `E1701M_OK` in case function could be completed successfully or an `E1701M_ERROR_`-code otherwise

void E1701M_close(unsigned char n)

Closes the connection to a card and releases all related resources. After this function was called, no more commands can be sent to the card until `E1701M_set_connection()` and `E1701M_open_connection()` are called again.

Parameters:

n – the 1-based board instance number as returned by `E1701M_set_connection()`

int E1701M_set_accels(unsigned char n, unsigned char axes, double accel, double decel, double stopDecel)

Set acceleration (ramping) values for acceleration, deceleration and in case a stop-event occurs. When one of the values is set to 0, related acceleration/deceleration will not be performed and the axis is started or stopped immediately. This may lead to rough movements or to overshoot with losing its exact position.

Acceleration and deceleration is not given in a value that is equal to a physical measurement unit but as a factor that describes strength of acceleration and depends on used acceleration mode.

This command is sent to the card asynchronously, there is no response for it.

Parameters:

n – the 1-based board instance number as returned by `E1701M_set_connection()`

axes – flags that specify for which axes these parameters have to be set, here OR-concatenated

`E1701M_AXIS_x`-flags have to be used; when referencing is running for one or more of the axes specified here, this command is dropped for these axes

accel – acceleration of selected axes on start, this value applies when a movement begins

decel – deceleration of selected axes on end, this value applies when a movement has to stop regularly; this deceleration is also used on referencing when reference-switch could not be found and axis stops movement due to position-timeout

stopDecel – deceleration of selected axes in case of stop condition, this value applies when movement is stopped by a stop-command or because a switch was hit or left; this deceleration is also used on referencing when a reference switch is hit or left

PLEASE NOTE: setting a stop deceleration value greater than 0 lets the related axes continue their movement



for the time required for deceleration, means no immediate stop is performed. Depending on situation this may result in run over limit or reference switches which may be unwanted. So deceleration value given here should be as large as possible to have an as small as possible deceleration time and travel distance!

Return: E1701M_OK in case function could be completed successfully or an E1701M_ERROR_-code otherwise

```
int E1701M_set_accel_modes(unsigned char n, unsigned char axes, unsigned int accelMode, unsigned int decelMode, unsigned int res2)
```

Sets or changes acceleration and deceleration mode of axes. By default linear mode is selected, using this function an other mode can be chosen.

Parameters:

n - the 1-based board instance number as returned by E1701M_set_connection()

axes - flags that specify for which axes these parameters have to be set, here OR-concatenated

E1701M_AXIS_x-flags have to be used; when referencing is running for one or more of the axes specified here, this command is dropped for these axes

accelMode - acceleration mode to be set for specified axes, here one of the following values is possible:

- E1701M_ACCEL_MODE_LIN - linear acceleration mode, here acceleration is constant until nominal speed is reached, this is a smooth mode where speed is reached not very fast
- E1701M_ACCEL_MODE_EXP - exponential acceleration mode, here acceleration increases with speed which lets the axis reach the target speed quite fast but may cause problems when acceleration is set to 0, in some situations here increments may get lost
- E1701M_ACCEL_MODE_SSHAPE - very soft acceleration mode where acceleration itself increases during beginning and decreases before target speed is reached, this mode can be used to have high speeds with inertial masses and without losing any increments but it reaches target speed slower than all other modes

decelMode - deceleration mode to be set for specified axes, here one of the following values can be handed over:

- E1701M_DECEL_MODE_LIN - linear mode, here deceleration is constant until axis is stopped, this is a smooth mode where stopping an axis doesn't happens very fast
- E1701M_DECEL_MODE_EXP - exponential mode, here axis starts with a high deceleration value which decreases over time and stops with a small deceleration. In this mode axis is stopped quite fast but may cause problems at the beginning when using the high deceleration, in some situations here increments may get lost
- E1701M_DECEL_MODE_SSHAPE - very soft deceleration mode where deceleration itself increases during beginning and decreases before axis is stopped, this mode can be used to stop from high speeds with inertial masses and without losing any increments but it stops slower than all other modes

res - unused parameter, set to 0 to be compatible with future versions

Return: E1701M_OK in case function could be completed successfully or an E1701M_ERROR_-code otherwise

```
int E1701M_set_limits(unsigned char n, unsigned char axes, int llimit, int hlimit, double slimit)
```

Set maximum movement range and speed limit for all subsequent motion commands. This command is sent to the card asynchronously, there is no response for it.

Parameters:

n - the 1-based board instance number as returned by E1701M_set_connection()

axes - flags that specify for which axes these parameters have to be set, here OR-concatenated

E1701M_AXIS_x-flags have to be used; when referencing is running for one or more of the axes specified here, this command is dropped for these axes

llimit - lower movement limit, when a later call specifies a movement position beyond this value, this movement is limited

`hlimit` – upper movement limit, when a later call specifies a movement position beyond this value, this movement is limited

`slimit` – speed limit (using unit increments/second); when this value is set to 0, later calls for setting a speed value are used with the given speed and without any limitation. In case a speed limit was specified, all used speed values are limited to the value given here.

Return: `E1701M_OK` in case function could be completed successfully or an `E1701M_ERROR_`-code otherwise

int E1701M_set_speed(unsigned char n, unsigned char axes, double speed)

Set axis speed for next movement command.

This command is sent to the card asynchronously, there is no response for it.

Parameters:

`n` – the 1-based board instance number as returned by `E1701M_set_connection()`

`axes` – flags that specify for which axes these parameters have to be set, here OR-concatenated

`E1701M_AXIS_x`-flags have to be used; when referencing is running for one or more of the axes specified here, this command is dropped for these axes

`speed` – movement speed in unit increments/second for next motion command, this value has to be greater than 0

Return: `E1701M_OK` in case function could be completed successfully or an `E1701M_ERROR_`-code otherwise

int E1701M_move_abs(unsigned char n, unsigned char axes, int pos)

Move axes to an absolute position.

This is a synchronous command, using `E1701M_get_axis_state()` it has to be checked if this movement has started and finished before any other command can be sent to the card. During an axis is running, it is only allowed to send motion commands for other, currently not running axes, stop-commands, or any commands that request state/position/speed data for axes.

Parameters:

`n` – the 1-based board instance number as returned by `E1701M_set_connection()`

`axes` – flags that specify which axes have to be moved, here OR-concatenated `E1701M_AXIS_x`-flags have to be set; when referencing is running for one or more of the axes specified here, this command is dropped for these axes

`pos` – absolute position to move the axis to (in unit increments)

Return: `E1701M_OK` in case function could be completed successfully or an `E1701M_ERROR_`-code otherwise

int E1701M_move_rel(unsigned char n, unsigned char axes, int pos)

Move axes by a distance relative to their current position.

This is a synchronous command, using `E1701M_get_axis_state()` it has to be checked if this movement has started and finished before any other command can be sent to the card. During an axis is running it is only allowed to send motion command for other, currently not running axes, stop-commands, or any commands that request state/position/speed data for axes.

Parameters:

`n` – the 1-based board instance number as returned by `E1701M_set_connection()`

`axes` – flags that specify which axes have to be moved, here OR-concatenated `E1701M_AXIS_x`-flags have to be set; when referencing is running for one or more of the axes specified here, this command is dropped for these axes

`pos` – relative position the specified axes have to be moved by (in unit increments)

Return: `E1701M_OK` in case function could be completed successfully or an `E1701M_ERROR_`-code otherwise

```
int E1701M_set_stopcond(unsigned char n, unsigned char axes, unsigned char stopOnEnter, unsigned char stopOnLeave)
```

Defines stop-conditions for axes. This function gives the possibility to freely define inputs as limit switches at which a movement has to stop. Here two states for inputs can be defined that are used as stop condition: when a switch is entered (input is set to HIGH) or when a switch is left (input goes to LOW). It is possible to use more than one input for stopping a motion. In this case at least one `stopOnEnter` input bit has to be set or all `stopOnLeave` input bits have to be reset to fulfill a stop condition.



PLEASE NOTE: when external encoder 0 or 1 is configured, input bits 0 and 1 or 2 and 3 are not available for checking stop condition.

When all input bits for “stop on enter” and “stop on leave” are set to 0, this function is disabled and motion works independent from input states.

As long as a stop condition is fulfilled, no more motion is possible. In this case the stop condition specified with this function has to be cleared by setting `stopOnEnter` and `stopOnLeave` to 0, axis has to be moved in other direction until the switches are in a state where stop condition is no longer fulfilled and previous stop condition values have to be restored. If movement was stopped by such a condition can be checked by calling `E1701M_get_axis_state()`. Which inputs are high and which are low (to find out which switches caused the stop and in which direction to move next) can be checked by calling `E1701M_get_inputs()`.

This command is sent to the card asynchronously, there is no response for it.

Parameters:

`n` – the 1-based board instance number as returned by `E1701M_set_connection()`

`axes` – flags that specify for which axes the stop conditions have to be set, here OR-concatenated

`E1701M_AXIS_x`-flags have to be used; when referencing is running for one or more of the axes specified here, this command is dropped for these axes

`stopOnEnter` – bit pattern specifying which input pins stop movement on HIGH-signal

`stopOnLeave` – a bit pattern specifying which input pins have to be LOW to stop movement

Return: `E1701M_OK` in case function could be completed successfully or an `E1701M_ERROR_`-code otherwise

```
int E1701M_enable(const unsigned char n, const char enable3, const char enable7)
```

When the fourth axis is not used, their related step and direction outputs can be used as two freely switchable digital outputs which can be used to enable/disable connected stepper motor drivers. With this function this mode can be activated or the fourth axis can be reactivated by turning off the disable mode.

This function requires firmware version 28 or newer.

Parameters:

`n` – the 1-based board instance number as returned by `E1701M_set_connection()`

`enable3` – set one of the following parameters here to control the function of the digital output “Enable3”:

`E1701M_ENABLE_OFF` – turn off the functionality to enable/disable connected devices and use the related outputs to drive a fourth axis; when this value is used, it has to be set for parameter `enable7` too, both outputs have to be operated in same mode, mixing of functions “enable/disable” and “drive axis” is not possible

`E1701M_ENABLE_LOW` – activate the enable-functionality and set the output “Enable3” to LOW; when this value is set, all motion commands for the fourth axis are dropped

`E1701M_ENABLE_HIGH` – activate the enable-functionality and set the output “Enable3” to HIGH;

when this value is set, all motion commands for the fourth axis are dropped

`enable7` – set one of the following parameters here to control the function of the digital output “Enable7”:

`E1701M_ENABLE_OFF` – turn off the functionality to enable/disable connected devices and use the related outputs to drive a fourth axis; when this value is used, it has to be set for parameter `enable3` too, both outputs have to be operated in same mode, mixing of functions “enable/disable” and “drive axis” is not possible

possible

`E1701M_ENABLE_LOW` - activate the enable-functionality and set the output "Enable7" to LOW; when this value is set, all motion commands for the fourth axis are dropped

`E1701M_ENABLE_HIGH` - activate the enable-functionality and set the output "Enable7" to HIGH; when this value is set, all motion commands for the fourth axis are dropped

Return: `E1701M_OK` in case function could be completed successfully or an `E1701M_ERROR_`-code otherwise

```
int E1701M_reference(unsigned char n, unsigned char axes, unsigned int mode,  
unsigned char refSwitch, double speedStep1, double speedStep2, double  
speedStep3, double speedStep4)
```

This function starts a reference run for specified axes. This requires one input pin to be used as switch defining the reference position. As long as referencing is active, all other commands sent for this axis (defined by axis flags of other functions) are ignored and dropped. Motion commands for other axes than the referenced ones still can be sent to the controller and will be processed in parallel.

This is a synchronous command, using `E1701M_get_axis_state()` it has to be checked if referencing has started and finished before any other command can be sent to the card.

Reference movements start with the standard acceleration specified with `E1701M_set_accels()` and stops with the stop-deceleration specified with `E1701M_set_accels()`.

When a stop-condition is met during referencing by hitting a limit switch for the first time, referencing direction is inversed to auto-search for reference switch.

When a stop-condition is met during referencing by hitting a limit switch for the second time, referencing is canceled. This can be checked via the `E1701M_AXIS_STATE_CONDSTOP`-flag of function

`E1701M_get_axis_state()`.

After referencing has finished successfully, function `E1701M_set_pos()` can be called to assign a defined position value to the current axis position.

Parameters:

`n` - the 1-based board instance number as returned by `E1701M_set_connection()`

`axes` - flags that specify for which axes referencing has to be started, here OR-concatenated

`E1701M_AXIS_x`-flags have to be used

`mode` - this is a bunch of OR-concatenated `E1701M_REFSTEP_x_y`-flags where `x` is the number of the step and `y` defines the movement that has to be performed during this referencing step. `x` has to be continuous, every number specified for `x` is allowed to exist only once. Here following flags do exist and can be combined to specify a referencing sequence:

- `E1701M_REFSTEP_1_ENTER_N` - on first step move in negative direction until the reference switch is hit
- `E1701M_REFSTEP_1_ENTER_P` - on first step move in positive direction until the reference switch is hit
- `E1701M_REFSTEP_2_ENTER_N` - on second step move in negative direction until the reference switch is hit
- `E1701M_REFSTEP_2_ENTER_P` - on second step move in positive direction until the reference switch is hit
- `E1701M_REFSTEP_2_LEAVE_N` - on second step move in negative direction until the reference switch is left
- `E1701M_REFSTEP_2_LEAVE_P` - on second step move in positive direction until the reference switch is left
- `E1701M_REFSTEP_3_LEAVE_N` - on third step move in negative direction until the reference switch is left
- `E1701M_REFSTEP_3_LEAVE_P` - on third step move in positive direction until the reference switch is left
- `E1701M_REFSTEP_3_ENTER_N` - on third step move in negative direction until the reference switch is hit
- `E1701M_REFSTEP_3_ENTER_P` - on third step move in positive direction until the reference switch is hit

- `E1701M_REFSTEP_4_ENTER_N` - on fourth step move in negative direction until the reference switch is hit
- `E1701M_REFSTEP_4_ENTER_P` - on fourth step move in positive direction until the reference switch is hit
- `E1701M_REFSTEP_4_LEAVE_N` - on fourth step move in negative direction until the reference switch is left
- `E1701M_REFSTEP_4_LEAVE_P` - on fourth step move in positive direction until the reference switch is left
- `E1701M_REFSTEP_INV_SWITCH` - this is a special flag which has influence on the logic of the input switch; when set, its behaviour is inverted, means reaction on hit/leave as described above changes; this option requires firmware version 23 or newer

Some examples for useful combinations:

- `E1701M_REFSTEP_1_ENTER_N|E1701M_REFSTEP_2_LEAVE_P|E1701M_REFSTEP_3_ENTER_N|E1701M_REFSTEP_4_LEAVE_P` - this is for very accurate referencing and requires related speed values becoming slower for every step. Here axis moves in negative direction until reference switch is hit, next it moves in positive direction until it is left. This is repeated, next it again moves in negative direction until reference switch is hit, during last step it moves in positive direction until it is left again. As lower the speed for step 4 is, as more exact the referenced position will be.
- `E1701M_REFSTEP_1_ENTER_P|E1701M_REFSTEP_2_ENTER_N|E1701M_REFSTEP_3_LEAVE_N` - this is a special sequence that assumes the reference switch may be hit but traversed in first step because speed is too high or stop-deceleration too slow to fully stop the axis while the switch is held. So after traveling in positive direction until the switch is hit, the axes move back in negative direction until the switch is hit again. Next movement in negative direction is continued until the switch is left. Here optionally a fourth step `E1701M_REFSTEP_4_ENTER_P` could be added to hit the reference switch again

`refSwitch` - bit pattern defining at least one input pin that is used as reference input. In theory it is possible to define more than one input bit for more than one reference switch here. In this case referencing would act on the first reference switch found during motion. In practice multiple-reference-switch-feature should be useful in very few, exotic cases only.

 PLEASE NOTE: when external encoder 0 or 1 is configured, input bits 0 and 1 or 2 and 3 are not available for usage as reference switch input.

`speedStep1` - speed to be used during first referencing step. When a speed value ≤ 0 is set here although a `E1701M_REFSTEP_1_`-flag is set, referencing will not be done

`speedStep2` - speed to be used during second referencing step. When a speed value ≤ 0 is set here although a `E1701M_REFSTEP_2_`-flag is set, referencing will be finished after step 1

`speedStep3` - movement speed to be used during third referencing step. When a speed value ≤ 0 is set here although a `E1701M_REFSTEP_3_`-flag is set, referencing will be finished after step 2

`speedStep4` - movement speed to be used during fourth referencing step. When a speed value ≤ 0 is set here although a `E1701M_REFSTEP_4_`-flag is set, this last step will not be done

Return: `E1701M_OK` in case function could be completed successfully or an `E1701M_ERROR_`-code otherwise

`int E1701M_set_pos(unsigned char n, unsigned char axes, int pos)`

Sets a specific position for defined axes. This function does not cause any movements but changes the current position value of the axis. When an axis makes use of the encoder input, the encoder counter is set to a value that corresponds to this position, for all other axes the internal position counter is set to the given value. This command is sent to the card asynchronously, its success can be tested by checking `E1701M_AXIS_STATE_SETPOS` flag returned by `E1701M_get_axis_state()`

Parameters:

`n` - the 1-based board instance number as returned by `E1701M_set_connection()`

`axes` - flags that specify for which axes the positions have to be set, here OR-concatenated `E1701M_AXIS_x`-flags have to be used; when referencing is running for one or more of the axes specified here, this command is dropped for these axes
`pos` - new position value for the axes specified by flags in parameter `axes` (using unit increments)

Return: `E1701M_OK` in case function could be completed successfully or an `E1701M_ERROR_`-code otherwise

```
int E1701M_set_trigger_point(unsigned char n,unsigned char axes,unsigned int input)
```

Waits with execution of all following commands until specified input lines go to HIGH. When the input is already on HIGH value, command execution is continued latest after 1 microseconds (assumed the next command is already sent and therefore waiting for execution). This is a queue command, it can be sent asynchronously followed by an other command that is executed immediately after the specified input was switched. Also when no movement is active while waiting for the input, this command sets movement-state. Waiting for an external signal can be cancelled by calling `E1701M_stop()` which also removes all other, enqueued commands. Alternatively `E1701M_release_trigger_point()` can be called which is similar to reception of an external trigger, it continues execution with next enqueued command.

Parameters:

`n` - the 1-based board instance number as returned by `E1701M_set_connection()`

`axes` - flags that specify for which axes a trigger point has to be set, here OR-concatenated `E1701M_AXIS_x`-flags have to be used; when referencing is running for one or more of the axes specified here, this command is dropped for these axes

`input` - bit pattern that has to be set at digital inputs, when more than one bit is specified here, all the inputs have to go to HIGH in order to continue operation (AND-concatenation).

 PLEASE NOTE: when external encoder 0 or 1 is configured, input bits 0 and 1 or 2 and 3 are not available for usage as external trigger input.

Return: `E1701M_OK` in case function could be completed successfully or an `E1701M_ERROR_`-code otherwise

```
int E1701M_release_trigger_point(unsigned char n,unsigned char axes)
```

This command is some kind of software trigger event. When execution is stopped by a command `E1701M_set_trigger_point()` it can be continued without an external signal just by calling this function for a specified axis. Calling this function when not waiting for an external trigger does not have any effect, any later call to `E1701M_set_trigger_point()` will override and reset the information given here.

Parameters:

`n` - the 1-based board instance number as returned by `E1701M_set_connection()`

`axes` - flags that specify for which axes these external trigger has to be released, here OR-concatenated `E1701M_AXIS_x`-flags have to be used; when referencing is running for one or more of the axes specified here, this command is dropped for these axes

Return: `E1701M_OK` in case function could be completed successfully or an `E1701M_ERROR_`-code otherwise

```
int E1701M_set_sync_point(unsigned char n,unsigned char axes)
```

Waits with execution of all following commands until commands of all axes that got the same synchronisation are waiting at this point. So this function can be used to synchronise command queues between axes, it ensures all commands following after this one are executed (nearly) immediately. This is useful e.g. for synchronising motion commands where all axes have to work in parallel. After all specified axes have arrived at this command, a next command that was issued directly after this is executed within 1 microsecond. This time is valid only for execution of commands within the same queue, delay between commands of different queues/axes

synchronised by this function is several magnitudes shorter.

This is a queue command, it can be sent asynchronously followed by an other command that is executed immediately after all specified axis command queues have arrived at this synchronisation point. When no movement is active while waiting for synchronisation between axes, this command sets movement-state. Waiting for synchronisation can be canceled by calling `E1701M_stop()`.

Parameters:

`n` – the 1-based board instance number as returned by `E1701M_set_connection()`

`axes` – flags that specify which axes have to wait for synchronisation. Here a bit pattern containing flags for at least two axes has to be set, elsewhere the command does nothing.

Return: `E1701M_OK` in case function could be completed successfully or an `E1701M_ERROR_`-code otherwise

`int E1701M_delay(unsigned char n, unsigned char axes, double delay)`

Waits with execution of all following commands for a given time. This is a queue command, it can be sent asynchronously followed by an other command that is executed immediately after the specified time has elapsed. Also when no movement is active while waiting for the input, this command sets movement-state. Waiting for the delay to elapse can be cancelled by calling `E1701M_stop()`, which also drops all other, enqueued commands.

Parameters:

`n` – the 1-based board instance number as returned by `E1701M_set_connection()`

`axes` – flags that specify for which axes a delay has to be done, here OR-concatenated `E1701M_AXIS_x`-flags have to be used; when referencing is running for one or more of the axes specified here, this command is dropped for these axes

`delay` – time to wait until marking continues in unit seconds, smallest possible value is 1 microsecond

Return: `E1701M_OK` in case function could be completed successfully or an `E1701M_ERROR_`-code otherwise

`int E1701M_set_enc(unsigned char n, char axis, unsigned char encoder, double resolution)`

Enables or disables quadrature decoder input for a specific axis. A maximum of two encoders can be used and only one axis can make use of the same encoder, so whenever an other axis is chosen, the previously used axis is no longer able to make use of this encoder.

Parameters:

`n` – the 1-based board instance number as returned by `E1701M_set_connection()`

`axis` – 0-based axis number (but not flag!) of the axis the decoder has to be used for; when -1 is given here, the quadrature encoder input is disabled and related digital inputs be used as reference or limit switch inputs

`encoder` – the number of the decoder to be used, for decoder 0 digital inputs 0 and 1 are used and can't work as limit or reference switches any longer, for encoder 1 digital inputs 2 and 3 are used and can't work as limit or reference switches any longer

`resolution` – factor between encoder pulses and the related number of increments, here a value has to be given in unit pulses per increment that specifies, how much increments the stepper motor has done when one set of encoder pulses (two 90 degree phase shifted, single pulses) was detected at encoder inputs

Return: `E1701M_OK` in case function could be completed successfully or an `E1701M_ERROR_`-code otherwise

`int E1701M_stop(unsigned char n, unsigned char axes)`

Stops movement of a running axis and drops all possibly enqueued commands.

This is a synchronous command, no other functions can be used until `E1701M_get_axis_state()` signals

the axis has stopped successfully.

Parameters:

`n` - the 1-based board instance number as returned by `E1701M_set_connection()`

`axes` - flags that specify which axes have to be stopped and queued commands for which axes have to be dropped, here OR-concatenated `E1701M_AXIS_x`-flags have to be used

Return: `E1701M_OK` in case function could be completed successfully or an `E1701M_ERROR_`-code otherwise

unsigned int E1701M_get_axis_state(unsigned char n, unsigned char axis)

Returns movement flags that tell state of an axis since last call of this function. To find out if movement is still in progress for a specific axis, this function has to be called again and the same flag has to be checked.



PLEASE NOTE: this function has always to be used together with all movement functions to implement a handshake:

1. start movement
2. check if movement has started
3. check if movement has finished.

Only after such a sequence next movement is allowed to be started. Same is true for referencing, here sequence is

1. start referencing
2. wait until referencing state flag is set
3. wait until referencing movement has finished.

Due to asynchronous data transmission to and from motion controller this function just fetches state data from a queue which is synchronous to the movement functions called. When `E1701M_get_axis_state()` is NOT used accidentally but motion commands are sent repeatedly, this internal state-queue may overrun resulting in an undefined behavior of the whole API.

Parameters:

`n` - the 1-based board instance number as returned by `E1701M_set_connection()`

`axis` - 0-based axis number (but not flag!) of the axis the state has to be checked for

Return: a list of OR-concatenated flags specifying the state of the given axis, here following values are possible:

- `E1701M_AXIS_STATE_MOVING` - axis is moving
- `E1701M_AXIS_STATE_REFERENCING` - axis is referencing; in some cases this flag may be set while `E1701M_AXIS_STATE_MOVING` is not set, this happens when referencing is still in progress but axis stopped for a short time
- `E1701M_AXIS_STATE_CONDSTOP` - axis was stopped because a stop condition specified by `E1701M_set_stopcond()` was fulfilled
- `E1701M_AXIS_STATE_SETPOS` - a new position value was set to current axis position successfully

double E1701M_get_axis_speed(unsigned char n, unsigned char axis)

Return movement speed of one specific axis (in unit increments per second). When speed value is 0, the axis is not moving. Since this method is not very accurate due to a lag caused by data transfer to and from controller, for exact motion detection always function `E1701M_get_axis_state()` has to be used.

Parameters:

`n` - the 1-based board instance number as returned by `E1701M_set_connection()`

`axis` - 0-based axis number (but not flag!) of the axis the current speed has to be evaluated for

Return: speed of the specified axis

```
int E1701M_get_axis_pos2(const unsigned char n, const unsigned char axis, long *position)
```

Gives back the position of one specific axis (in unit increment). When no encoder is used and configured for this axis, the returned value is the assumed position it should have after all preceding operations, but it does not necessarily need to be equal to the real position. Especially in cases where steps have been dropped due to overload or motor has continued movement due to overshooting, the assumed and the actual position can be quite different. When an encoder is used and configured for the specified axis, the returned value is equal to the position counted by the encoder. Here only possible deviation in accuracy is caused by rounding errors when calculation real incremental position out of the encoder position. This deviation depends on encoder's resolution and should be very small.

Parameters:

n - the 1-based board instance number as returned by `E1701M_set_connection()`

axis - 0-based axis number (but not flag!) of the axis the current position has to be evaluated for

position - pointer to a variable to store the current position of the given axis into, when the function returns with an error code but not with `E1701M_OK`, the value returned in this variable is undefined and can not be used

Return: `E1701M_OK` in case function could be completed successfully or an `E1701M_ERROR_`-code otherwise

```
unsigned int E1701M_get_inputs(unsigned char n)
```

Returns current state of digital inputs. When quadrature decoder 0 or 1 are used, the state of input bits 0 and 1 or 2 and 3 are undefined; they do not reflect the current decoder input state but any preceding input value. This function is executed asynchronously and returns immediately with the last known input state.

Parameters:

n - the 1-based board instance number as returned by `E1701M_set_connection()`

Return: bit pattern of current digital input

```
int E1701M_set_outputs(const unsigned char n, const unsigned int flags, const unsigned int value, const unsigned int mask)
```

This function is intended to be used in IO-mode only where E1701M is used as plain IO-board. It can be used to set the 8 bit digital outputs directly.

Parameters:

n - the 1-based board instance number as returned by `E1701D_set_connection()`

flags - unused, set to 0 for compatibility with future software versions

mask - specifies which of the bits in "*value*" have to be used for setting and clearing output data, only these bits that are set to 1 in *mask* are changed according to the given *value*

value - the 8 bit value to be set at digital out port

Return: `E1701M_OK` or an `E1701M_ERROR_` return code in case of an error

```
void E1701M_get_version(unsigned char n, unsigned short *hwVersion, unsigned short *fwVersion)
```

Get the hardware and software version of the used board.

This is not a handshake command, it is executed immediately and independent from all other commands.

Parameters:

n - the 1-based board instance number as returned by `E1701M_set_connection()`

hwVersion - the hardware revision/version number

`fwVersion` – the revision/version number of the firmware running on the board

8.1.1 E1701M Binary API Error Codes

Functions described above in most cases return a generic error code or `E1701M_OK` in case the operation could be completed successfully. In case of an error one of the following codes is returned:

- `E1701M_ERROR_INVALID_CARD` – a wrong or illegal card number was specified for function parameter “n”
- `E1701M_ERROR_NO_CONNECTION` – host could not connect to card either because of a network error (Ethernet connection) or because of some USB connection problems
- `E1701M_ERROR_NO_MEMORY` – there is not enough memory available on host system
- `E1701M_ERROR_UNKNOWN_FW` – the board is running with an unknown or incompatible firmware; for firmware updates please refer above
- `E1701M_ERROR_TRANSMISSION` – data transmission from host to card failed possibly because of connection problems
- `E1701M_ERROR_FILEOPEN` – opening of a file failed
- `E1701M_ERROR_FILEWRITE` – writing of data into an already opened file failed
- `E1701M_ERROR_INVALID_DATA` – a function was called with invalid data or by using an operation mode where this function is not used/allowed
- `E1701M_ERROR_UNKNOWN_BOARD` – trying to access a controller board that is not a motion controller
- `E1701M_ERROR` – an other, unspecified error happened

8.2 E1701M ASCII Commands

The ASCII-commands can be sent via serial interface (in case USB connection is used). An appropriate client has to connect to the serial port (`COMx` for Windows and `/dev/ttyACMx` for Linux where “x” is a number identifying the specific serial interface). As soon as the connection is established, commands can be sent to the card. All commands come with following structure:

`cxxxx[a] [parameter(s)]`

The commands always start with character “c”. Next four characters identify the command itself. In most cases it is followed by a number in range 0..3 specifying the axis this command is valid for. Depending on the command one or more optional or mandatory parameters may follow. Some commands that are not specific to an axis do not make use of the axis number “a” and therefore consist of 5 characters only.

Following commands are supported:

camoda mode

Set mode for acceleration. Here `a` is an required parameter specifying the axis (in range 0..3) the mode has to be set for. Acceleration mode to be used is specified by parameter `mode`, here one of following values is possible:

- 1 – linear acceleration mode, acceleration is constant until nominal speed is reached, this is a smooth mode where speed is reached not very fast
- 2 – exponential acceleration mode, here acceleration increases with speed which lets the axis reach the target speed quite fast but may cause problems when acceleration is set to 0 at end of acceleration phase, in some situations increments may get lost at this point
- 3 - very soft s-shaped acceleration mode where acceleration itself increases during beginning and decreases before target speed is reached, this mode can be used to have high speeds with inertial masses and without losing any increments but it reaches target speed slower than all other modes

Example: `camod3 1` – set linear acceleration mode for axis 3

cacce [acceleration]

Set or show acceleration strength factor for an axis that is applied whenever a movement starts. *a* is an required parameter and specifies the axis in range 0..3 this command is valid for. When called with no parameter, this command returns the current acceleration in unit "strength factor * 1000". When a positive parameter value is specified, this value is set as new acceleration and used for all further movements. Setting an acceleration value of 0 disables this function completely, all movements will start without any ramping in this case.

Example: `cacce0 2500` – sets an acceleration of 2.5 for axis 0

cdmoda mode

Set mode for deceleration. Here *a* is an required parameter specifying the axis (in range 0..3) the mode has to be set for. Deceleration mode to be used is specified by parameter *mode*, one of following values is possible:

- 1 – linear deceleration mode, here deceleration is constant until axis is fully stopped, this is a smooth mode where axes aren't stopped very fast
- 2 – exponential deceleration mode, here axis starts with a high deceleration value which decreases over time and lets the axis stop quite fast but may cause problems when deceleration is started, in some situations here increments may get lost at the beginning of deceleration
- 3 - very soft s-shaped deceleration mode where deceleration itself increases during beginning and decreases before axis is stopped fully, this mode can be used to stop from high speeds with inertial masses and without losing any increments but it stops speed slower than all other modes

Example: `cdmod3 1` – set linear deceleration mode for axis 3

cdecea [deceleration]

Set or show deceleration strength factor for an axis that is applied whenever a movement stops regularly. *a* is an required parameter and specifies the axis in range 0..3 this command is valid for. When called with no parameter, this command returns the current deceleration in unit "strength factor * 1000". When a positive parameter value is specified, this value is set as new deceleration and used for all further movements. Setting a deceleration value of 0 disables this function completely, all movements will stop without any ramping in this case.

Example: `cdece1` – prints the current acceleration value for axis 1

csdeca [stopdeceleration]

Set or show deceleration strength factor for an axis that is applied whenever a movement stops due to an unpredictable event like a stop-command or like hitting a reference or limit switch. *a* is an required parameter and specifies the axis in range 0..3 this command is valid for. When called with no parameter this command returns the current deceleration in unit "strength factor * 1000". When a positive parameter value is specified, this value is set as new deceleration and used for all further operations. Setting a deceleration value of 0 disables this function completely, related movements will stop without any ramping in this case.

Example: `csdec2 75000` – sets a new stop-acceleration of 75.0 for axis 2

cllima [lowlimit]

Set or show current lower limit the axis "*a*" is allowed to drive to (in unit increments). When a motion command is given that would move axis beyond this point, movement stops at position specified by "*lowlimit*" using

current deceleration value.

Example: `c1lim3` – show current lower limit position of axis 3

chlima [highlimit]

Set or show current upper limit the axis “a” is allowed to drive to (in unit increments). When a motion command is given that would move axis beyond this point, movement stops at position specified by “highlimit” using current deceleration value.

Example: `chlim0 50000` – set the upper limit of axis 3 to 50000 increments

cslima [speedlimit]

Set or show current speed limit for axis “a” (in unit increments per second * 1000). When a motion speed is set that is higher than the value given here, it will be limited to the speed specified by “speedlimit”. Setting this speed limit also influences the current motion speed specified by command `cmspd`, it will be limited too so that speed limitation applies to all following movements without sending `cmspd` again.

Example: `cslim1 1500000` – set a speed limit of 1500 increments per second

cmspda [motionspeed]

Set or show speed used for movements at axis “a” (in unit increments per second * 1000). The value given here will be used for all following movement commands until it is replaced by an other motion speed value set with this command. When a speed is higher than the speed limit defined by a preceding call of `cslim`, it is limited to that maximum speed.

Example: `cmspd2` – show motion speed value used for movements

ccspda

Show current speed axis “a” is moving with (in unit increments per second * 1000). If the specified axis is not moving, returned speed is 0.

Example: `ccspd3` – show speed axis 3 is currently moving with

ccposa

Show current position of axis with number “a” (in unit increments). When no encoder is used for this axis the assumed position is returned. This position is generated out of all preceding the movements and is the nominal position the axis should have after these operations. This position may differ from the real position of the hardware in case steps have been generated but motor could not move due to overload or in case motor overshoots at end of movements. When an encoder is used, this command returns the position generated out of the encoder data. This is the more exact value since it takes all deviations caused by mechanics into account. This command can be used during a motion is in progress to check position changes.

Example: `ccpos1` – show current position of axis 1

cstcda [stoponenter stoponleave]

Shows the current stop condition bits or sets new condition and input bits to be used as condition to stop the given axis "a". This command can be used to configure inputs to be used as limit switches where motion has to stop. Both parameters expect a bit pattern specifying the inputs to be used. When bits are set, motion will stop when at least one of the input bits specified with "stoponenter" is set to high (switch is hit) or when all input bits specified with "stoponleave" are going low (switches are left). When both are set to 0 this function is disabled.

When motion has been stopped by such a condition, the related axis is no longer able to move since the condition is still valid. Thus first the condition has to be removed, next the axis has to be moved in opposite direction far enough to not to fulfil the stop condition any longer. If an axis has been stopped by such a condition can be checked by using command "cstst". The state of the inputs can be evaluated using command "cginp". When decoder 0 or 1 is used, inputs 0 and 1 or 2 and 3 are not available for usage.

Example: `cstcd2` - show the input bits currently used at axis 2 for stop condition, when "0 0" is returned, this function is disabled

Example: `cstcnd3 48 0` - sets the two inputs 4 (=16) and 5 (=32) to be used as limit switches for axis 3, motion will stop as soon as one of these inputs is set to high

Example: `cstcnd0 0 3` - sets the two inputs 0 (=1) and 1 (=2) to be used as limit switches for axis 0, motion will stop as soon as both inputs are going to low

cststa

Checks if a stop condition is active for the given axis "a". As soon as a stop-condition was fulfilled that caused an axis to stop, an internal flag is set. Calling this function the related flag can be checked. When it returns 1, the last movement was stopped by an external condition, in case of 0 motion was not stopped by it. Executing this command resets the flag, so all further calls would return a 0 until a new movement is performed that fulfils this condition again. Starting a new movement also resets this flag, so executing this command should be done once after a motion is stopped and current axis speed is 0.

Example: `cstst0` - returns 1 when stop condition was fulfilled during last movement on axis 0

cmabsa [position]

Move axis "a" to the specified "position" (using unit increments). This command uses speed, acceleration and deceleration values set with `cmspd`, `cacce` and `cdece`.

Example: `cmabs3 3000` - move axis 3 to absolute position of 3000

cmrela [distance]

Move axis "a" and change its current position by given "distance" (using unit increments). This command uses speed, acceleration and deceleration values set with `cmspd`, `cacce` and `cdece`.

Example: `cmrel0 -2000` - move axis 2, change its position by 2000 increments in negative direction

cstopa

Stops movement on given axis "a" and drops all other possibly enqueued commands. Stopping a movement will be done using the stop-deceleration specified with command "csdec".

Example: `cstop1` - stops axis 1

csposa position

This command does not cause any movement but resets the internal position counter to the new value specified by "position". This command is useful together with "cmref" to specify the current, defined position after referencing has been done.

Example: `cspos2 0` – sets the current position of axis 2 to value 0

cstrga inputbits

This is a queue command that stops execution of all other, following motion commands until the inputs specified by "inputbits" are set. After the given input bits have been recognised, a next command that was issued directly after sending "cstrg" is executed within 1 microsecond.

When this command was sent, execution of all following commands is held until:

- `cstop` is called for same axis – all following commands for this axis are dropped
- correct external trigger signal is detected – next command is executed
- `crtrg` is called for same axis – next command is executed

 PLEASE NOTE: when quadrature decoder 0 or 1 is used, digital inputs 0 and 1 or 2 and 3 are not accessible this way and should not be used as external trigger signal.

Example:

```
cstrg3 8  
cmabs3 10000
```

This sequence stops execution of all commands for axis 3 until digital input 3 (=8) is set to high. As soon as this happens, axis 3 moves to position 10000. Commands that would have been sent for other axes than this would have been executed without any influence by "cstrg3".

crtrga

Using this command a "wait for trigger"-sequence can be interrupted and execution of commands is continued.

Example: `crtrg0` – a trigger command at axis 0 is released, all commands that have been sent after preceding "cstrg0" are executed

csynca axisflags

This is a queue command that stops execution of all other, following motion commands for the specified axes until all axes switched to synchronisation mode have reached this point. So this can be used to synchronise command queues between axes, it ensures all commands following after this one are executed (nearly) immediately. This is useful for synchronising motion commands where all axes have to work in parallel. This command has to be sent for all axes that need synchronisation.

Parameter `axisflags` is a bit pattern that specifies which axes have to wait for each other, this is a number consisting of following OR-concatenated values:

- 1 – axis 0
- 2 – axis 1
- 4 – axis 2
- 8 – axis 3

After all specified axes have arrived at this command, a next command that was issued directly after sending `csync` is executed within 1 microsecond. This time is valid only for execution of commands within the same queue, delay between commands of different queues/axes synchronised by this function is several magnitudes shorter.

When this command was sent, execution of all following commands is held until:

- `cstop` is called for these axes
- all specified axes arrive at this synchronisation point

Example:

```
csync2 12
cmabs2 10000
csync3 12
cmabs3 5000
```

This command sequence ensures axis 2 and 3 stop until command queue of both axes have arrived at the synchronisation point. After that both axes start movement (nearly) at the same time. "cmabs2 10000" is not executed before "csync3 12" is emitted, so it starts immediately with this command and together with the following "cmabs3 5000"

csdlya delay

Stop execution at axis "a" for the given time. Here "delay" specifies the time (in unit microseconds) execution of next queued command has to wait. Such a delay can be cancelled by calling "cstop".

Example:

```
cmabs1 1000
csdly1 1500000
cmabs1 2000
```

This sequence lets axis 1 move to position 1000, after arrival it waits for 1.5 seconds and continues movement to position 2000.

cmrefa mode refswitch speed1 speed2 speed3 speed4

This command performs referencing at axis "a". Here up to four referencing steps can be defined using "mode". All these steps are done in relation to the input bit of the reference switch specified by "refswitch". Every step can be done with a different referencing speed ("speed1"..."speed4").

Parameter "mode" is a combination of numbers which are equal to the E1701M_REFSTEP_x_y flags described above. Here every step is equal to a number, to combine different movements of these steps, the numbers have to be added. Every step is allowed to exist only once. When there is a gap in steps (e.g. step 1,2 and 4 defined) referencing ends before that gap and all following steps are dropped. When a given speed value is 0, referencing ends before this step. Following numbers are available to get a referencing sequence for parameter "mode":

For first step one of following numbers can be used:

- 1 – on first step move in negative direction until the reference switch is hit
- 2 – on first step move in positive direction until the reference switch is hit

One of following numbers can be added for step 2:

- 4 – on second step move in negative direction until the reference switch is hit
- 8 – on second step move in positive direction until the reference switch is hit
- 16 – on second step move in negative direction until the reference switch is left
- 32 – on second step move in positive direction until the reference switch is left

One of following numbers can be added for step 3:

- 64 – on third step move in negative direction until the reference switch is left
- 128 – on third step move in positive direction until the reference switch is left
- 256 – on third step move in negative direction until the reference switch is hit
- 512 – on third step move in positive direction until the reference switch is hit

One of following numbers can be added for step 4:

- 1024 – on fourth step move in negative direction until the reference switch is hit
- 2048 – on fourth step move in positive direction until the reference switch is hit
- 4096 – on fourth step move in negative direction until the reference switch is left
- 8192 – on fourth step move in positive direction until the reference switch is left

Some examples for useful combinations of parameter "mode":

- 8481 (=1+32+256+2048) – this is for very accurate referencing and requires related speed values becoming slower for every step. Here axis moves in negative direction until reference switch is hit, next it moves in positive direction until it is left. This is repeated, next it again moves in negative direction until

reference switch is hit, during last step it moves in positive direction until it is left again. As lower the speed for step 4 is, as more exact the referenced position will be.

- 70 (=2+4+64) – this is a special sequence that assumes the reference switch may be hit but traversed in first step because speed is too high or stop-deceleration too slow to fully stop the axis while the switch is held. So after traveling in positive direction until the switch is hit, the axes move back in negative direction until the switch is hit again. Next movement in negative direction is continued until the switch is left. Here optionally a fourth step 2048 could be added to hit the reference switch again

Second parameter “refswitch” is a bit pattern specifying the input that has to be watched during referencing.



PLEASE NOTE: when decoder 0 or 1 is used, digital inputs 0 and 1 or 2 and 3 are not accessible this way and can't be used as reference switch inputs.

Example: `cmref2 2 4 100000 0 0 0` – performs a simple referencing where axis moves in positive direction until digital input bit 2 goes to high. Referencing is done with a speed of 100.0 increments per second. Since whole referencing sequence consists of one step only, speed values for step 2 to 4 are set to 0.

csenca [encodernum resolution]

Configures one of the two available quadrature decoders to the axis specified by “a” or shows the current decoder configuration of this axis. When no additional parameters are given, the current axis decoder configuration consisting of used decoder number and resolution is returned. When this axis does not make use of an encoder, “off” is given back.

To enable and configure a decoder for this axis, the decoder number “encodernum” in range 0..1 and its resolution (in unit “factor” between encoder pulses and the related number of increments * 100000) has to be specified.

To disable an encoder input for an axis, the number of decoder to be disabled and a resolution of -1 has to be specified.

When decoder 0 is used, input lines 0 and 1 are required for encoder signals and no longer can be used as limit/reference switch/tigger inputs.

When decoder 1 is used, input lines 2 and 3 are required for encoder signals and no longer can be used as limit/reference switch/trigger inputs.

Examples:

`csenc3 0 1235000` – enable encoder 0 (input bits 0 and 1) for axis 3, one increment of motor is equal to 1.235 encoder pulses for this axis

`csenc0 1 -1` – disable encoder 1, input bits 2 and 3 are available for use as stop or reference switch afterwards; here axis specifier “0” does not matter since there will be no longer an assignment of the disabled encoder to any axis

csena ab

Sets the enable mode and state for digital outputs “Enable3” and “Enable7”. Here a and b are single-digit numbers which define the state for “Enable3”-output (a) and “Enable7”-ouput (b). Both always have to be set together and can have following values:

0 – operate Enable3 and Enable7 outputs in “enable” mode and set the related output to LOW; in this mode all motion commands for the fourth axis are dropped

1 – operate Enable3 and Enable7 outputs in “enable” mode and set the related output to HIGH; in this mode all motion commands for the fourth axis are dropped

2 – operate Enable3 and Enable7 outputs in “drive axis” mode for the fourth axis and disable the “enable” functionality; this value always has to be set for bot, a and b, it can not be defined for one of them only

Examples:

`csena 22` – turn off the “enable”-functionality and use the related outputs to drive the fourth axis

`csena 10` – turn off the fourth axis, set output “Enable3” to HIGH and “Enable7” to LOW

`csena 01` – turn off the fourth axis, set output “Enable3” to LOW and “Enable7” to HIGH

This command requires firmware version 28 or higher.

cginp

Shows the current state of digital inputs. When decoder 0 or 1 is used, state of input bits 0 and 1 or 2 and 3 are undefined and do not reflect their current state.

csout outbits

Set the bit pattern specified by "outputs" at the digital outputs for step and direction. Here the digital outputs are set and cleared according to the given bit pattern. **HANDLE WITH CARE:** This command is executed immediately and independent from any other (motion) command. Dependent on what bit pattern is set with this command, it can invert motion direction and/or cause a single step. So this command should never be used when any other operation is in progress or only in case E1701M is used as IO-board and without motor control functionality! Elsewhere after setting some outputs it may be necessary to perform a new reference run in order to get axis position and internal position counter working synchronously.

Example: `csout 12` - set the step and direction output of axis 1 to HIGH while outputs of all other axes go to LOW.

cecho mode

Setting a `mode` of 0 disables echoing of data sent to the controller. In this case only responses are sent back.

This mode is useful when accessing controller out of an application.

With `mode 1` echoing is enabled, this is useful for manual operations where user types commands and likes to get a key press feedback. So when accessing controller via serial interface out of an application first command sent to it should be `echo 0` while dropping all received data until an "OK:" is detected.

cglog

Get next line of buffered log information. As long as there are some more log data available, this call returns the next log message and removes it from internal buffer. In case there are no more log messages available an error message is returned. To get all current log messages this command has to be used repeatedly. When the command is never called during operation the internal log buffer is filled continuously. As soon as there is no more space left in log buffer, all following log messages are dropped. Now when `cglog` is called it will of course not be able to show the dropped messages. In this case it is important to keep in mind that there can be a gap in log buffer, new log messages are appended as soon as old ones are removed by calling this command.

APPENDIX A – IDC connector pin numbering

Pin numbering of the IDC connectors (according to pinout-tables shown in hardware description sections above) can be seen in below image:

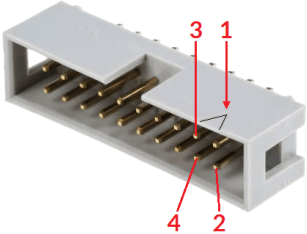

The first pin is marked by a small arrow in connector. Second pin is below of it, counting continues column-wise.

APPENDIX B – Board dimensions

Board dimension drawings all values are given in unit mm.

Connectors, bottom view:

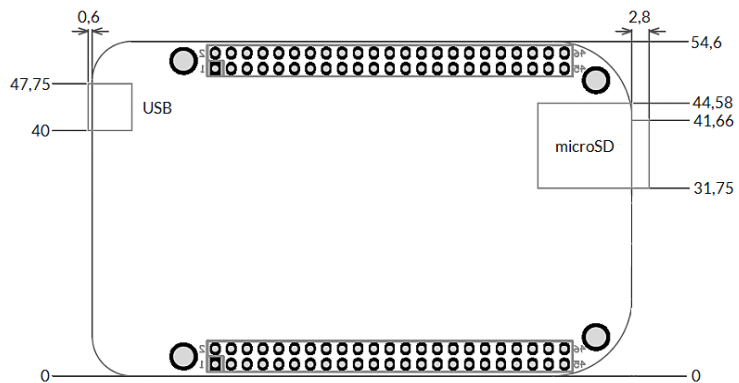

Connectors, top view:

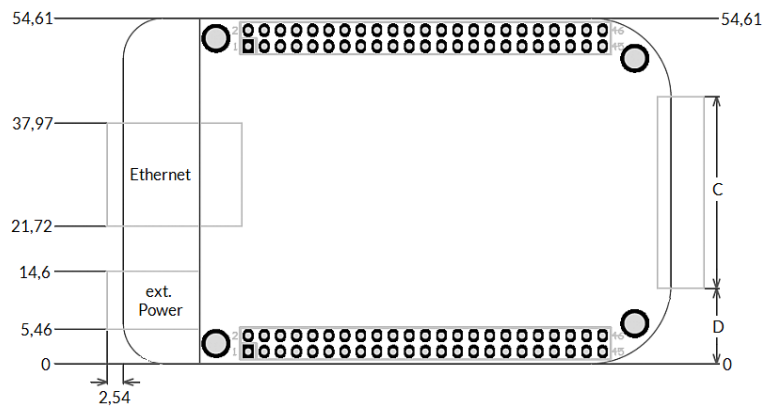

	C	D
Interface connector dimensions	34 mm	10,3 mm

Dimensions, top view:

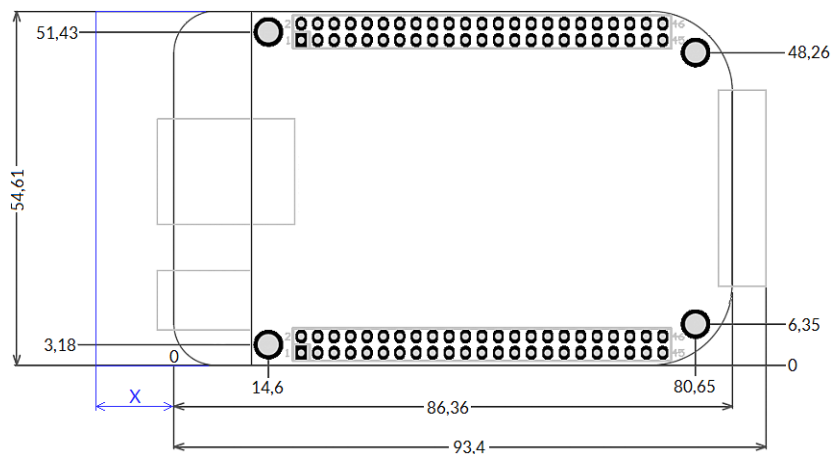

X – for future compatibility leave additional space of 10 mm at Ethernet connector side of the controller

E1701base dimension drawing, all values are given in unit mm.

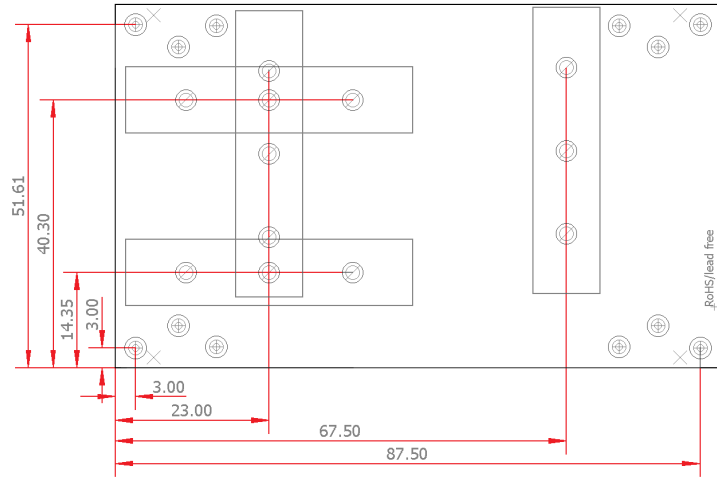

Index

B

boot..... 15

C

cacce..... 33
camoda..... 32
ccposa..... 34
ccspda..... 34
cdecea..... 33
cdmoda..... 33
cecho..... 39
cginp..... 39
cglog..... 14, 39
chlima..... 34
cllima..... 33
cmabsa..... 35
cmrefa..... 37
cmrela..... 35
cmspda..... 34
controller log data..... 22
crtrga..... 36
csdeca..... 33
csdlya..... 37
csena..... 38
csenca..... 38
cslima..... 34
csout..... 39
csposa..... 36
cstcda..... 34
cstopa..... 35
cstrga..... 36
cststa..... 35
csynca..... 36

D

digidebc..... 15
dimension drawing..... 41p.
dimensions..... 41
DIN rail..... 20
DIN rail adapter..... 20
DIN rail lock..... 20

E

E1701M_ACCEL_MODE_EXP..... 23
E1701M_ACCEL_MODE_LIN..... 23
E1701M_ACCEL_MODE_SSHAPE..... 23
E1701M_AXIS_STATE_CONDSTOP..... 26, 30
E1701M_AXIS_STATE_MOVING..... 30
E1701M_AXIS_STATE_REFERENCING..... 30
E1701M_AXIS_STATE_SETPOS..... 27, 30
E1701M_close()..... 22
E1701M_DECEL_MODE_EXP..... 23
E1701M_DECEL_MODE_LIN..... 23

E1701M_DECEL_MODE_SSHAPE.....	23
E1701M_delay().....	29
E1701M_ENABLE_HIGH.....	25p.
E1701M_ENABLE_LOW.....	25p.
E1701M_ENABLE_OFF.....	25
E1701M_enable().....	25
E1701M_ERROR.....	32
E1701M_ERROR_FILEOPEN.....	32
E1701M_ERROR_FILEWRITE.....	32
E1701M_ERROR_INVALID_CARD.....	32
E1701M_ERROR_INVALID_DATA.....	32
E1701M_ERROR_NO_CONNECTION.....	32
E1701M_ERROR_NO_MEMORY.....	32
E1701M_ERROR_TRANSMISSION.....	32
E1701M_ERROR_UNKNOWN_BOARD.....	32
E1701M_ERROR_UNKNOWN_FW.....	32
E1701M_get_axis_pos2().....	31
E1701M_get_axis_speed().....	30
E1701M_get_axis_state().....	30
E1701M_get_inputs().....	31
E1701M_get_version().....	31
E1701M_move_abs().....	24
E1701M_move_rel().....	24
E1701M_open_connection().....	22
E1701M_reference().....	26
E1701M_REFSTEP_1_ENTER_N.....	26
E1701M_REFSTEP_1_ENTER_P.....	26
E1701M_REFSTEP_2_ENTER_N.....	26
E1701M_REFSTEP_2_ENTER_P.....	26
E1701M_REFSTEP_2_LEAVE_N.....	26
E1701M_REFSTEP_2_LEAVE_P.....	26
E1701M_REFSTEP_3_ENTER_N.....	26
E1701M_REFSTEP_3_ENTER_P.....	26
E1701M_REFSTEP_3_LEAVE_N.....	26
E1701M_REFSTEP_3_LEAVE_P.....	26
E1701M_REFSTEP_4_ENTER_N.....	27
E1701M_REFSTEP_4_ENTER_P.....	27
E1701M_REFSTEP_4_LEAVE_N.....	27
E1701M_REFSTEP_4_LEAVE_P.....	27
E1701M_REFSTEP_INV_SWITCH.....	27
E1701M_release_trigger_point().....	28
E1701M_set_accels().....	22
E1701M_set_connection().....	21
E1701M_set_enc().....	29
E1701M_set_limits().....	23
E1701M_set_logfile().....	22
E1701M_set_outputs().....	31
E1701M_set_password().....	21
E1701M_set_pos().....	27
E1701M_set_speed().....	24
E1701M_set_stopcond().....	25
E1701M_set_sync_point().....	28
E1701M_set_trigger_point().....	28
E1701M_stop().....	29
electrostatic sensitive device.....	6
ESD.....	6
eth.....	15
Ethernet.....	10, 15

F	
Firmware.....	15
I	
initfile.....	14
IO-board.....	7, 17, 31, 39
J	
JOG1.....	14, 18
jogspd0.....	14, 19
jogspd15.....	14, 19
P	
pethd.....	15
S	
stand-alone.....	14, 18
W	
Windows.....	10